

KAWAI

PROFESSIONAL STAGE PIANO **MP10**
Owner's Manual v1.03

Introduction

Basic Operation

MIDI Functions

EDIT Menu

STORE Button & SETUPS

Recorder

USB Menu

SYSTEM Menu

Appendix

Thank you for purchasing this Kawai MP10 stage piano.

This owner's manual contains important information regarding the usage and operation of the MP10 stage piano. Please read all chapters carefully, keeping this manual handy for future reference.

■ About this Owner's Manual

Before attempting to play this instrument, please read the **Introduction** chapter from page 10 of this owner's manual. This chapter provides a brief explanation of each section of the MP10's control panel, an overview of its various jacks and connectors, and details how the components of the instrument's sound is structured.

The **Basic Operation** chapter (page 18) provides an overview of the instrument's most commonly used functions, beginning with turning sections on and off, adjust their volume, and selecting sounds. Later on, this chapter introduces basic sound adjustment using the four control knobs, before examining how EFX, reverb, amp simulation, and EQ can all be applied to dramatically change the character of the selected sound. The chapter closes with an explanation of the instrument's metronome/drum pattern and transpose functions.

The **MIDI Functions** chapter (page 31) demonstrates how the MP10 can be used as a MIDI controller, while the **EDIT Menu** chapter (page 34) lists all available PIANO, E.PIANO, SUB, and MIDI section parameters by category for easy reference. **The STORE Button & SETUP Menus** chapter (page 47) outlines storing customised sounds, capturing the entire panel configuration as a SETUP, then recalling different SETUPS from the MP10's internal memory.

The **Recorder** section (page 51) provides instructions on how to record and play back pieces stored both in the instrument's internal memory, and also MP3/WAV audio files saved to USB memory devices. Additional USB functions are covered in greater detail in the **USB Menu** chapter (page 66), while the **SYSTEM Menu** chapter (page 72) explains the **MP10's System Settings and various reset functions**.

Finally, the **Appendix** section (page 76) includes listings of the instrument's internal sounds and drum rhythms, MIDI reference information, and full specification details.

Welcome to the MP10

■ MP10 Feature Highlights

The best keyboard action available in a stage piano

The MP10 utilises Kawai's *RM3 Grand* wooden-key action, incorporating various grand piano action characteristics, such as contrasting hammer weights - appropriately graded for each playing range - bass key counter-balancing, and correctly located pivot points for both black and white keys. This unique 'seesaw' movement provides a consistent, evenly balanced action, while finely textured *Ivory Touch* key surfaces not only enhance the enjoyment of playing, but also help to absorb moisture, thus preventing fingers from slipping.

In addition, the MP10's keyboard action is equipped with a special *Let-off* feature, accurately recreating the subtle 'click' sensation felt when playing the keys of a grand piano very gently.

PIANO section: The ultimate grand pianos for Concert, Pop, and Jazz

The MP10 captures the beautiful sound of Kawai's highly acclaimed hand-built concert grand piano, with all 88 keys of this exceptional instrument meticulously recorded, analysed and faithfully reproduced using proprietary Ultra Progressive Harmonic Imaging™ technology. This unique process accurately recreates the broad dynamic range of the original grand piano, affording pianists an extraordinary level of expressiveness ranging from the softest pianissimo to the strongest, boldest fortissimo.

With separate categories for Concert, Pop, and Jazz playing, the MP10 offers the finest selection of high quality acoustic piano sounds ever compiled for a Kawai instrument, while additional techniques and effects, such as string and damper resonance, and subtle key-release sounds, are also applied, delivering a rich selection of vibrant piano tones with breathtaking realism and authenticity.

E.PIANO section: Brand new vintage EPs, twin effects, and amp sim

The MP10 features a selection of brand new vintage electric piano sounds, each with their own distinctive characteristics. Enjoy their natural, organic sound, or pass the signal through a variety of classic effects stomp boxes, before playing it through one of the six classic amp and speaker cabinets

SUB section: High quality strings, pads, and more

The MP10's SUB section features high quality strings, pads, and other useful sounds that are ideal for layering with acoustic or electric pianos, or for playing individually, at the front of the mix. Feature functions such as Bell and Sweep add further variety to the sound, while typical ADSR parameters and resonance/cut-off can all be adjusted directly from the panel's assignable knobs.

MIDI section: Master keyboard controller

The MP10 features a dedicated MIDI section for controlling external devices, or integrating into the studio as a master keyboard. Use the assignable panel knobs to send CC# to connected hardware, or the recorder transport buttons to control a DAW without touching a mouse or leaving the piano. The MP10 even includes LINE IN jacks and a dedicated panel fader to adjust the level of connected devices, such as that old expander module or synth that you just can't live without, or a laptop running software instruments.

Intuitive operation, large LCD, real-time assignable control knobs

The MP10's control panel is clearly arranged and easy to use, with related functions grouped together and placed where you'd expect to find them. A large LCD display and four assignable control knobs, allow several parameters to be adjusted directly in real-time, without getting lost in menus - concentrate on playing, rather than trying to remember which button does what.

156 Setup memories: enough for the busiest stage musician

The MP10 allows every single customised sound, knob position, fader level, and adjustable parameter to be stored in memory as a SETUP, and recalled at the touch of a button. With over 150 SETUP memories, the MP10 is ideal for busy stage musicians who like to plan several shows ahead, before going out on the road.

USB to Device functionality, with MP3/WAV/SMF file recording and playback.

The MP10 is equipped with USB connectors that not only allow the instrument to be connected to a computer for MIDI use, but also to load and save data to USB memory devices directly. This 'USB to Device' feature allows customised sounds, SETUP memories, and recorder songs stored in internal memory to be saved to USB for posterity.

USB memory devices can also be used to play back MP3 or WAV audio or SMF MIDI files, allowing performing musicians to play along with professional backing tracks, or simply learn the chords or melody for a new piece. It is even possible to save performances directly as MP3, WAV, or SMF files for emailing to band members, casual listening away from the keyboard, or further editing using an audio workstation.

Important Safety Instructions

SAVE THESE INSTRUCTIONS

INSTRUCTIONS PERTAINING TO A RISK OF FIRE, ELECTRIC SHOCK, OR INJURY TO PERSONS



WARNING

TO REDUCE THE RISK OF FIRE OR ELECTRIC SHOCK, DO NOT EXPOSE THIS PRODUCT TO RAIN OR MOISTURE.

AVIS : RISQUE DE CHOC ELECTRIQUE - NE PAS OUVRIR.

TO REDUCE THE RISK OF ELECTRIC SHOCK, DO NOT REMOVE COVER (OR BACK). NO USER-SERVICEABLE PARTS INSIDE. REFER SERVICING TO QUALIFIED SERVICE PERSONNEL.



The lightning flash with arrowhead symbol, within an equilateral triangle, is intended to alert the user to the presence of uninsulated "dangerous voltage" within the product's enclosure that may be of sufficient magnitude to constitute a risk of electric shock to persons.



The exclamation point within an equilateral triangle is intended to alert the user to the presence of important operating and maintenance (servicing) instructions in the literature accompanying the product.

Examples of Picture Symbols



denotes that care should be taken.
The example instructs the user to take care not to allow fingers to be trapped.



denotes a prohibited operation.
The example instructs that disassembly of the product is prohibited.



denotes an operation that should be carried out.
The example instructs the user to remove the power cord plug from the AC outlet.

Read all the instructions before using the product.

- 1) Read these instructions.
- 2) Keep these instructions.
- 3) Heed all warnings.
- 4) Follow all instructions.
- 5) Do not use this apparatus near water.
- 6) Clean only with dry cloth.
- 7) Do not block any ventilation openings. Install in accordance with the manufacturer's instructions.
- 8) Do not install near any heat sources such as radiators, heat registers, stoves, or other apparatus (including amplifiers) that produce heat.
- 9) Do not defeat the safety purpose of the polarized or grounding-type plug. A polarized plug has two blades with one wider than the other. A grounding type plug has two blades and a third grounding prong. The wide blade or the third prongs are provided for your safety. If the provided plug does not fit into your outlet, consult an electrician for replacement of the obsolete outlet.
- 10) Protect the power cord from being walked on or pinched particularly at plugs, convenience receptacles, and the point where they exit from the apparatus.
- 11) Only use attachments/accessories specified by the manufacturer.
- 12) Use only with the cart, stand, tripod, bracket, or table specified by the manufacturer, or sold with the apparatus. When a cart is used, use caution when moving the cart/apparatus combination to avoid injury from tip-over. 
- 13) Unplug this apparatus during lightning storms or when unused for long periods of time.
- 14) Refer all servicing to qualified service personnel. Servicing is required when the apparatus has been damaged in any way, such as power-supply cord or plug is damaged, liquid has been spilled or objects have fallen into the apparatus, the apparatus has been exposed to rain or moisture, does not operate normally, or has been dropped.

When using electrical products, the following basic precautions should always be followed:



WARNING

Indicates a potential hazard that could result in death or serious injury if the product is handled incorrectly.

The product should be connected to an AC outlet of the specified voltage.



- If you are going to use an AC power cord, make sure that its has the correct plug shape and conforms to the specified power voltage.
- Failure to do so may result in fire.

Do not insert or disconnect the power cord plug with wet hands.



Doing so may cause electric shock.

Take care not to allow any foreign matter to enter the product.

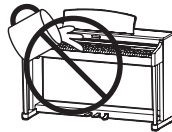

Entry of water, needles or hair pins may result in breakdown or short-circuit. The product shall not be exposed to dripping or splashing. No objects filled with liquids, such as vases, shall be placed on the product.

When using the headphones, do not listen for long periods of time at high volume levels.

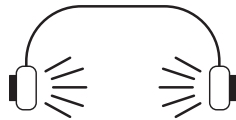

Doing so may result in hearing problems.

Do not disassemble, repair or modify the product.

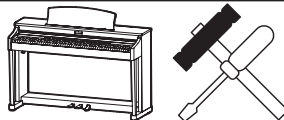

Doing so may result in product breakdown, electric shock or short-circuit.

When disconnecting the AC power cord's plug, always hold the plug and pull it to remove it.



- Pulling the AC power cord itself may damage the cord, causing a fire, electric shock or short-circuit.

The product is not completely disconnected from the power supply even when the power switch is turned off. If the product will not be used for a long time, unplug the AC power cord from the AC outlet.



- Failure to do so may cause fire in case of lightning.
- Failure to do so may over-heat the product, resulting in fire.

It is good practice to place the instrument near the AC outlet and the power cord plug in a position so that it can readily be disconnected in an emergency because electricity is always charging while the plug is in the AC outlet even in a power switch off condition.

Ensure that this product is connected to a socket with a protective earth connection.

GROUNDING INSTRUCTIONS

This product must be grounded. If it should malfunction or breakdown, grounding provides a path of least resistance for electric current to reduce the risk of electric shock. This product is equipped with a cord having an equipment-grounding conductor and a grounding plug. The plug must be plugged into an appropriate outlet that is properly installed and grounded in accordance with all local codes and ordinances.

DANGER - Improper connection of the equipment-grounding conductor can result in a risk of electric shock. Check with a qualified electrician or serviceman if you are in doubt as to whether the product is properly grounded. Do not modify the plug provided with the product - if it will not fit the outlet, have a proper outlet installed by a qualified electrician.



CAUTION

Indicates a potential hazard that could result in injury or damage to the product or other property if the product is handled incorrectly.

Do not use the product in the following areas.

- Areas, such as those near windows, where the product is exposed to direct sunlight
- Extremely hot areas, such as near a heater
- Extremely cold areas, such as outside
- Extremely humid areas
- Areas where a large amount of sand or dust is present
- Areas where the product is exposed to excessive vibrations

Using the product in such areas may result in product breakdown. Use the product only in moderate climates (not in tropical climates).

Before connecting cords, make sure that the power to this product and other devices is turned OFF.

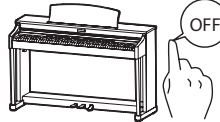

Failure to do so may cause breakdown of this product and other devices.

Do not drag the product on the floor. Take care not to drop the product.

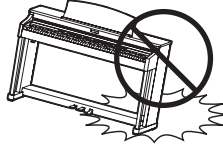

Please lift up the product when moving it. Please note that the product is heavy and must be carried by more than two persons. Dropping the product may result in breakdown.

Do not place the product near electrical appliances such as TVs and radios.

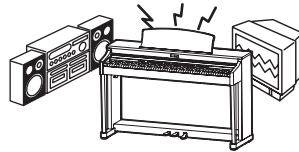

- Doing so may cause the product to generate noise.
- If the product generates noise, move the product sufficiently away from the electrical appliance or connect it to another AC outlet.

When connecting the AC power cord and other cords, take care not to get them tangled.



Failure to do so may damage them, resulting in fire, electric shock or short-circuit.

Do not wipe the product with benzene or thinner.



- Doing so may result in discoloration or deformation of the product.
- When cleaning the product, put a soft cloth in lukewarm water, squeeze it well, then wipe the product.

Do not stand on the product or exert excessive force.



- Doing so may cause the product to become deformed or fall over, resulting in breakdown or injury.

Do not place naked flame, such as lighted candles on the product.

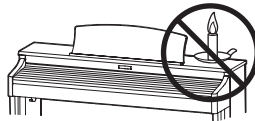

Doing so may cause the illumination to fall over, resulting in fire.

Ensure that the ventilation is not impeded by covering the ventilation openings with items, such as newspaper, table-cloths, curtains, etc.

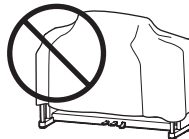

Failure to do so may over-heat the product, resulting in fire.

The product should be located so that its location or position does not interfere with its proper ventilation. Ensure a minimum distance of 5cm around the product for sufficient ventilation.

The product should be serviced by qualified service personnel when:

- The power supply cord or the plug has been damaged.
- Objects have fallen, or liquid has been spilled into the product.
- The product has been exposed to rain.
- The product does not appear to operate normally or exhibits a marked change in performance.
- The product has been dropped, or the enclosure damaged.

Notes on Repair

Should an abnormality occur in the product, immediately turn the power OFF, disconnect the power cord plug, and then contact the shop from which the product was purchased.

Instruction for AC power cord (U.K.)

WARNING: THIS APPARATUS MUST BE EARTHED

IMPORTANT: The wires in this mains lead are coloured in accordance with the following code:

- GREEN-AND-YELLOW: EARTH
- BLUE: NEUTRAL
- BROWN: LIVE

As the colours of the wires in the mains lead of this apparatus may not correspond with the coloured markings identifying the terminals in your plug, proceed as follows.

- The wire which is coloured GREEN-AND-YELLOW must be connected to the terminal in the plug which is marked by the letter E or by the safety earth symbol or coloured GREEN or GREEN-AND-YELLOW.
- The wire which is coloured BLUE must be connected to the terminal which is marked with the letter N or coloured BLACK.
- The wire which is coloured BROWN must be connected to the terminal which is marked with the letter L or coloured RED.



An information on Disposal for users

If your product is marked with this recycling symbol it means that, at the end of its life, you must dispose of it separately by taking it to an appropriate collection point. You should not mix it with general household waste. Disposing of this product correctly will prevent potential negative effects on the environment and human health which could otherwise arise due to inappropriate waste handling. For further details, please contact your local authority. (European Union only)

Canadian Radio Interference Regulations

This instrument complies with the limits for a class B digital apparatus, pursuant to the Radio Interference Regulations, C.R.C., c.1374.

FCC Information (U.S.A)

CAUTION: Changes or modifications not expressly approved by the party responsible for compliance could void the user's authority to operate the equipment.

NOTE: This equipment has been tested and found to comply with the limits for a Class B digital device, pursuant to Part 15 of the FCC Rules. These limits are designed to provide reasonable protection against harmful interference in a residential installation. This equipment generates, uses and can radiate radio frequency energy and, if not installed and used in accordance with the instructions, may cause harmful interference to radio communications. However, there is no guarantee that interference will not occur in a particular installation. If this equipment does cause harmful interference to radio or television reception, which can be determined by turning the equipment off and on, the user is encouraged to try to correct the interference by one or more of the following measures:

- Reorient or relocate the receiving antenna.
- Increase the separation between the equipment and receiver.
- Connect the equipment into an outlet on a circuit different from that to which the receiver is connected.
- Consult the dealer or an experienced radio/TV technician for help.



Declaration of Conformity

Products:	Electronic Piano
Model Number:	MP10
Responsible Party Name:	Kawai America Corporation
Address:	2055 East University Drive, Rancho Dominguez, CA 90220
Telephone:	310-631-1771

This device complies with Part 15 of the FCC Rules. Operation is subject to the following two conditions:
(1) this device may not cause harmful interference, and
(2) this device must accept any interference received, including interference that may cause undesired operation.

This applies only to products distributed by Kawai America Corporation.

Table of Contents

Welcome to the MP10	3
Important Safety Instructions	4
Table of Contents	8

Introduction

Part Names & Functions	10
1. Front Panel: Knobs, Faders & Buttons	10
2. Front Panel: Jacks & Connectors	14
3. Rear Panel: Jacks & Connectors	14
Connecting to Other Devices	16
Understanding the MP10	17

Basic Operation

Overview of Internal Sections	18
1. Section Basics	18
2. LCD Display & Control Knobs	19
3. Reverb	20
4. EFX	21
5. Amp Simulator (E.PIANO section only)	23
Internal Sections & Feature Parameters	24
1. PIANO section	24
2. E.PIANO section	25
3. SUB section	26
EQ Section	27
Additional Functions	28
1. Metronome	28
2. Panel Lock	29
3. Transpose	30

MIDI Functions

MIDI Section	31
USB MIDI (USB to Host Connector)	33

EDIT Menu

Overview of the EDIT Menu	34
EDIT Menu Parameters (PIANO, E.PIANO, SUB)	36
1. Reverb	36
2. EFX	36
3.1 Virtual Technician (PIANO)	37
3.2 Amp Simulator (E.PIANO)	38
3.3 Layer Tone (SUB)	38
4. Tuning	38
5. Keyboard Setup	40
6. Controllers	42
7. Knob Assign	43
8. Sound Edit	44
EDIT Menu Parameters (MIDI)	45
1. Program	45
2. Transmit	45
3. Receive	46
4. MMC	46

STORE Button & SETUPS

Overview of the STORE Button	47
1. Storing a SOUND	47
2. Storing a SETUP	48
3. Storing POWERON settings	49
SETUP memories	50

Recorder

Overview of the Recorder	51
Song Recorder (Internal memory)	52
1. Recording a song	52
2. Playing back a song	53
3. Saving a song as an SMF file	54
4. Converting a song to an audio file	54
5. Loading an SMF file into memory	55
6. Erasing a song	57
Audio Record/Playback (USB memory)	58
1. Recording an audio file	58
2. Playing an audio file	60
3. Overdubbing an audio file	62
4. Converting a song to an audio file	64

USB Menu

Overview of the USB Menu	66
USB Menu functions	67
1. Load	67
2. Save	68
3. Delete	69
4. Rename	70
5. Format	71

SYSTEM Menu

Overview of the SYSTEM Menu	72
SYSTEM Menu parameters	73
1. Utility	73
2. Offset	74
3. User	74
4. Reset	75

Appendix

Sound List	76
Rhythm Pattern List	77
Specifications	78
MIDI Implementation	79
1. Recognised Data	79
2. Transmitted Data	83
3. Exclusive Data	84
4. SOUND/SETUP Program/Bank	84
5. Control Change Number (CC#) Table	85
6. MIDI Implementation Chart	86
Software Update	87
Notes	88

Part Names & Functions

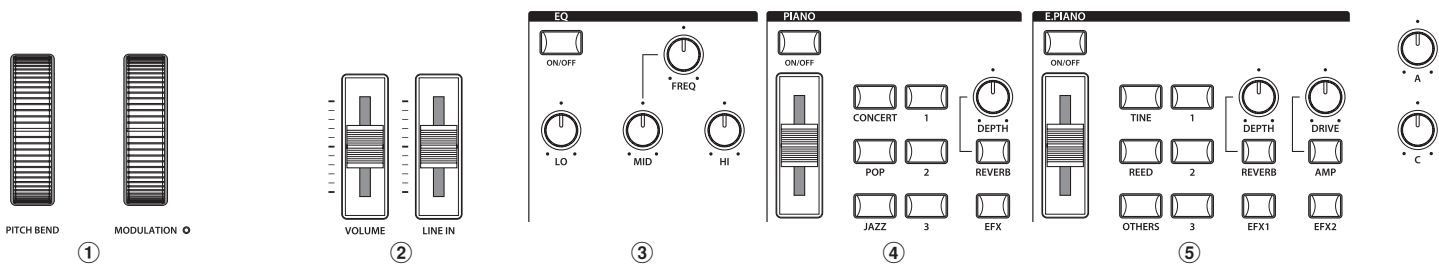

1 Front Panel: Knobs, Faders & Buttons

1 Control Wheels

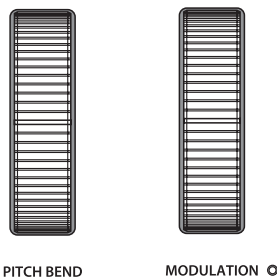

PITCH BEND wheel

This control wheel smoothly bends the pitch up or down from its current value.

MODULATION wheel

This control wheel controls the modulation (vibrato) depth. Moving the wheel forward increases the vibrato depth. The LED indicator will turn ON when this wheel is in use.

* Alternative functions can be assigned to the PITCH BEND and MODULATION wheels in the Controllers page of the EDIT menu (page 42).

2 Volume Faders

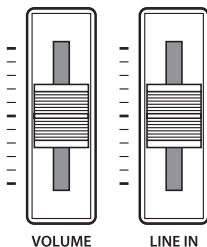

VOLUME fader

This fader controls the master volume level of the MP10's NORMAL OUTPUT and HEADPHONE jacks. It does not affect the volume level of the FIXED OUTPUT jacks.

LINE IN fader

This fader controls the LINE IN volume level.

3 EQ Section

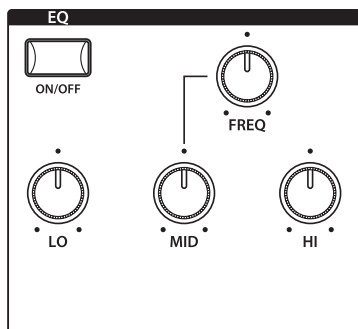

ON/OFF button

This button turns the three-band graphic equaliser ON or OFF. Press and hold this button to show the EQ settings page of the EDIT menu in the LCD display.

* The MP10's equaliser is common to PIANO, E.PIANO, and SUB sections, but does not affect LINE IN or USB AUDIO sound.

LO / MID / HI knobs

These knobs adjust the level of low-, mid-, and high-range frequencies.

FREQ knob

This knob adjusts the frequency of the mid-range EQ.

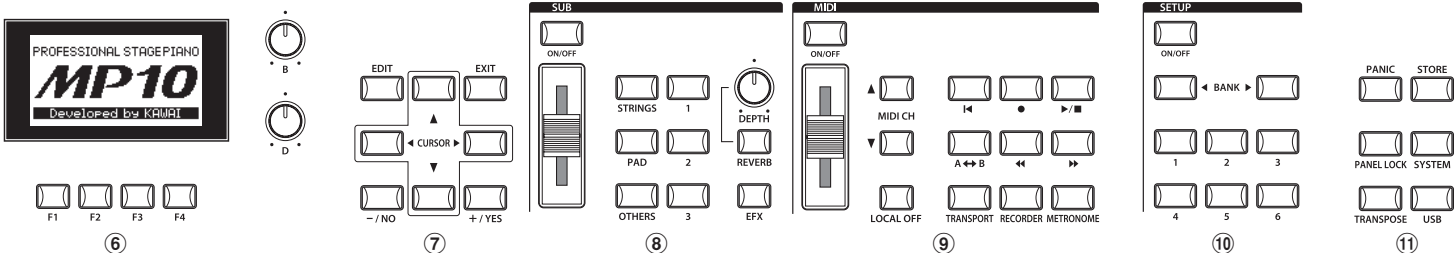

④ PIANO Section

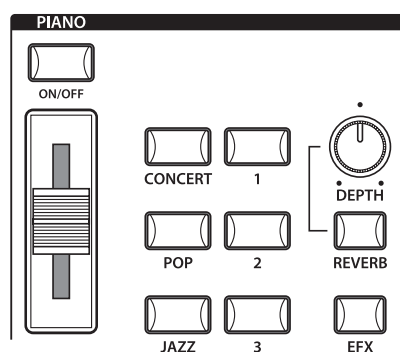

ON/OFF button

This button turns the PIANO section ON or OFF.

VOLUME fader

This fader controls the volume level of the PIANO section.

CONCERT/POP/JAZZ buttons

These buttons select the category of the piano sound.

1/2/3 buttons

These buttons select the piano sound from each category.

REVERB/EFX buttons

These buttons turn the reverb and effects ON or OFF.

Press and hold either button to show the reverb or effects settings pages of the EDIT menu in the LCD display.

DEPTH knob

This knob adjusts the depth setting of the reverb.

⑤ E.PIANO Section

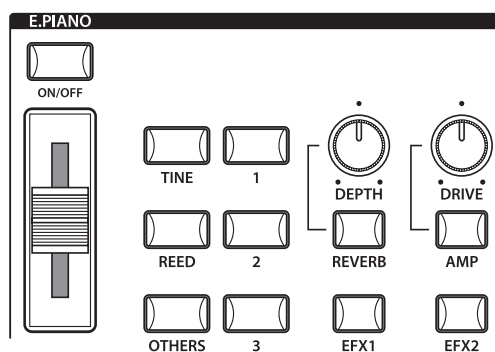

ON/OFF button

This button turns the E.PIANO section ON or OFF.

VOLUME fader

This fader controls the volume level of the E.PIANO section.

TINE/REED/OTHERS buttons

These buttons select the category of the e.piano sound.

1/2/3 buttons

These buttons select the e.piano sound from each category.

REVERB/EFX1/EFX2/AMP buttons

These buttons turn the reverb, primary/secondary effects, and amp simulator ON or OFF.

Press and hold either button to show the respective settings pages of the EDIT menu in the LCD display.

DEPTH knob

This knob adjusts the depth setting of the reverb.

DRIVE knob

This knob adjusts the drive setting of the amp simulator.

⑥ DISPLAY Section

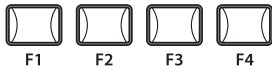
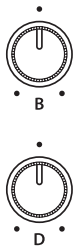
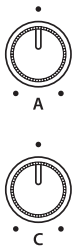

LCD Display

The LCD display provides a visual indication of the selected section and sound, parameter values, and the status of other functions when active.

A/B/C/D knobs

These knobs adjust displayed parameter values in real-time.

* EDIT menu parameters can be freely assigned to each of the four knobs in the Knob Assign page of the EDIT menu (page 43).

F1/F2/F3/F4 buttons

These buttons select the four main sections (PIANO, E.PIANO, SUB, MIDI) to be displayed and controlled. In other modes (e.g. Recorder) these buttons also select additional functions.

⑦ EDIT Section

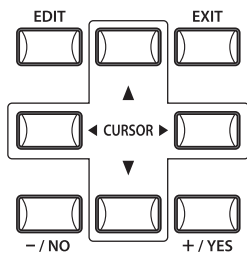

EDIT button

This button enters the EDIT menu. When the EDIT menu is displayed, this button also enters the selected parameter category page.

-/NO +/YES buttons

These buttons decrease or increase the value of the selected parameter, and also cancel or confirm operations that require user interaction (e.g. Erasing data).

CURSOR buttons

These buttons move the selection cursor and scroll through the various pages of the EDIT menu.

EXIT button

This button exits the current mode or page.

⑧ SUB Section

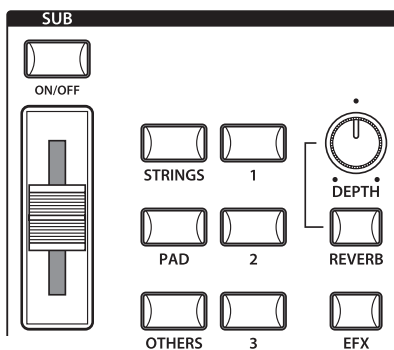

ON/OFF button

This button turns the SUB section ON or OFF.

VOLUME fader

This fader controls the volume level of the SUB section.

STRINGS/PAD/OTHERS buttons

These buttons select the category of the sub sound.

1/2/3 buttons

These buttons select the sub sound from each category.

REVERB/EFX buttons

These buttons turn the reverb and effects ON or OFF. Press and hold either button to show the reverb or effects settings pages of the EDIT menu in the LCD display.

DEPTH knob

This knob adjusts the depth setting of the reverb.

⑨ MIDI Section

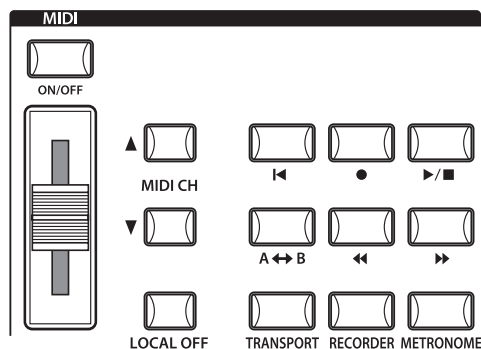

ON/OFF button

This button turns the MIDI section ON or OFF.

VOLUME fader

This fader sends the Channel Volume message CC#07 via MIDI.

MIDI CH buttons

These buttons select the MIDI transmitting channel.

LOCAL OFF

This button disables the internal connection between the MP10's keyboard and tone generators.

TRANSPORT button

This button enables assigned MMC (MIDI Machine Control) messages to be sent using the RECORDER CONTROL buttons.

RECORDER button

This button enables the MP10's internal song and USB audio recorder to be operated using the RECORDER CONTROL buttons.

METRONOME button

This button activates the METRONOME or RHYTHM patterns.

⑩ SETUP Section

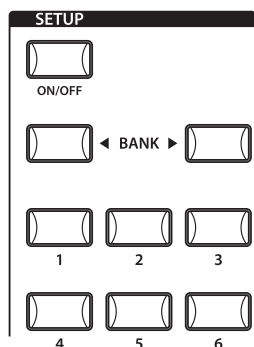

ON/OFF button

This button turns the SETUP section ON or OFF.

BANK buttons

These buttons select the SETUP bank from A to Z.

MEMORY buttons

These buttons select the SETUP memory from 1 to 6.

⑪ UTILITY Section

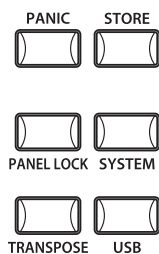

PANIC button

This button returns the MP10 to the Power On state, and also sends All Note Off and Reset All Controller messages via MIDI.

STORE button

This button is used to store the current panel settings.

PANEL LOCK button

This button locks the MP10's control panel, thus preventing any accidental button pushes during a performance.

SYSTEM button

This button enters the SYSTEM menu, allowing many aspects of the MP10's functionality to be adjusted.

USB button

This button enters the USB menu, allowing data to be loaded and saved from/to a connected USB memory device.

TRANSPOSE button

This button turns the TRANSPOSE function ON or OFF. Press and hold the button to show the transpose settings page in the LCD display.

2 Front Panel: Jacks & Connectors



HEADPHONE jack

The headphone jack is located at the left end of the key slip and used to connect a pair of headphones equipped with a standard 1/4" phone jack.

USB TO DEVICE port

The USB to Device port is located at the right end of the key slip and used to connect a FAT or FAT32 formatted USB memory device to load and save data.

3 Rear Panel: Jacks & Connectors

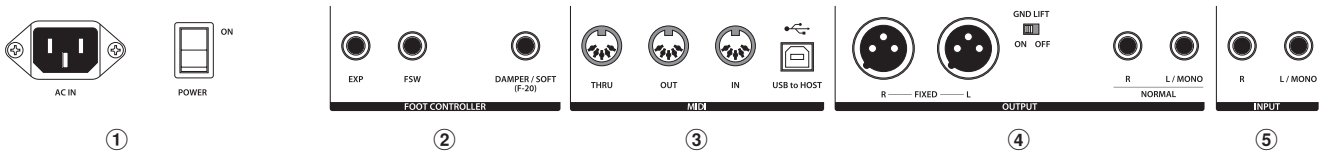

1 POWER Section

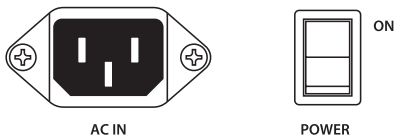

AC IN

Connect the power cable included with the MP10 to this receptacle.

POWER SWITCH

This switch turns the MP10 ON and OFF.

2 FOOT CONTROLLER Section

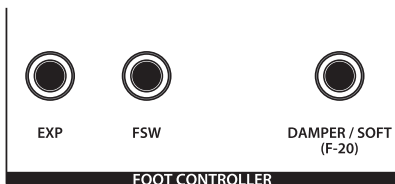

EXP jack

This jack is used to connect an expression pedal.

FSW jack

This jack is used to connect a momentary foot switch pedal.

DAMPER/SOFT (F-20) jack

This jack is used to connect the F-20 dual-pedal unit included with the MP10. By default, the right pedal acts as a damper pedal, while the left pedal functions as a soft pedal.

* Additional functions can be freely assigned to each foot controller in the Controllers page of the EDIT menu (page 42).

③ MIDI Section

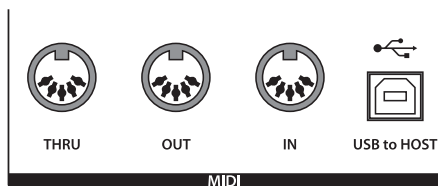

MIDI THRU/OUT/IN jacks

These jacks are used to connect the MP10 to external MIDI devices, and also to a computer with a MIDI interface as an alternative to the 'USB to Host' port.

USB TO HOST port

This port is used to connect the MP10 to a computer using a USB cable. When connected, the instrument can be used as a standard MIDI device, allowing it to send and receive MIDI data. Connect a 'B' type USB connector to the instrument, and an 'A' type USB connector to the computer.

* When connecting the MP10 to a computer using the 'USB to Host' port, additional driver software may be required (page 33).

④ OUTPUT Section

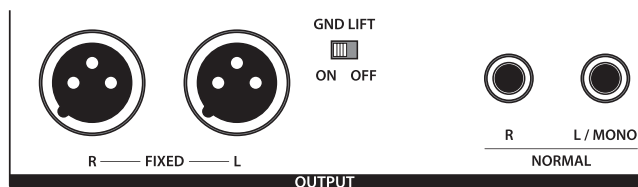

FIXED OUTPUT jacks

These jacks are used to connect the MP10 to a musical instrument amplifier, PA system, or recording console using XLR terminals.

The VOLUME fader does NOT affect these outputs.

GND LIFT switch

This switch is used to shut the ground loop that can occur when connecting the MP10 using XLR terminals.

This switch can typically be left in the OFF position.

NORMAL OUTPUT jacks

These jacks are used to connect the MP10 to a musical instrument amplifier, PA system, or recording console using standard 1/4" phone jacks. To output a mono signal, connect the cable to the L/MONO jack.

⑤ INPUT Section

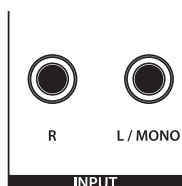

NORMAL INPUT jacks

These jacks are used to connect a pair of stereo outputs from other electronic instruments or audio equipment to the MP10. The input level can be easily adjusted using the LINE IN fader. When connecting a mono audio source, connect the cable to the L/MONO jack only.

* When using the Audio Recorder function, the INPUT audio will also be recorded to the WAV/MP3 file (page 58).

Connecting to Other Devices

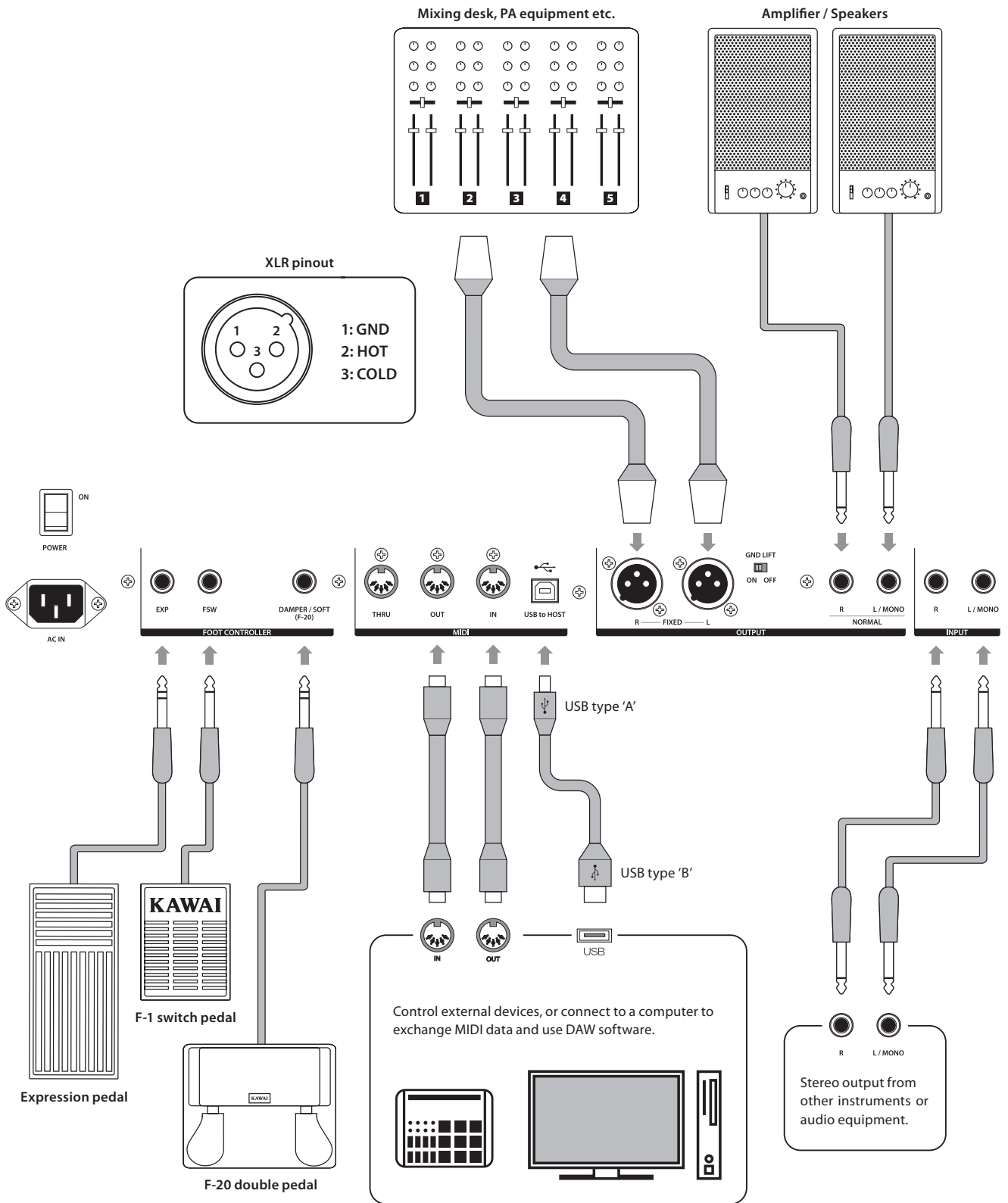

Understanding the MP10

■ Preparation before use

The MP10 does not feature built-in speakers. Therefore, in order to listen to the MP10, it will first be necessary to connect a mixer, keyboard amplifier, or headphones to the instrument.

Once connected to an audio output device, press the POWER SWITCH located on the right of the rear panel to turn on the MP10. It is recommended to turn on the MP10 before the audio output device in order to avoid the unpleasant switching noise that can sometimes occur.

■ MP10 section structure: explanation

The MP10 features 4 independent sections: PIANO, E.PIANO, SUB, and MIDI. Each section features a dedicated VOLUME fader and can be turned ON or OFF freely.

The PIANO, E.PIANO, and SUB sections all share largely the same operation, with 3 category buttons and 3 sounds assigned to each category (9 different sounds per section). The PIANO and SUB sound sections share one EFX module, while the E.PIANO section offers two separate EFX modules and an additional AMP simulator. All sounds can be adjusted using the various parameters in the EDIT menu, with additional 'Feature Parameters' that are specific to each of the three sound sections.

REVERB settings are common for all sound sections, however the DEPTH can be controlled independently for each section. Finally, the EQ controls are also common for all sound sections.

Modifications to each sound can be stored as individual SOUND presets, while the entire configuration of the MP10 itself can be stored in one of the 156 SETUP memories.

As noted previously, the master VOLUME fader does not affect the FIXED OUTPUT jacks, but does affect the NORMAL OUTPUT jacks. This allows audio engineers to control the level of the instrument at the mixing desk, while still allowing performers to adjust the volume of their monitor speakers freely.

■ MP10 section structure: block diagram

The diagram below illustrates the section structure of the MP10.

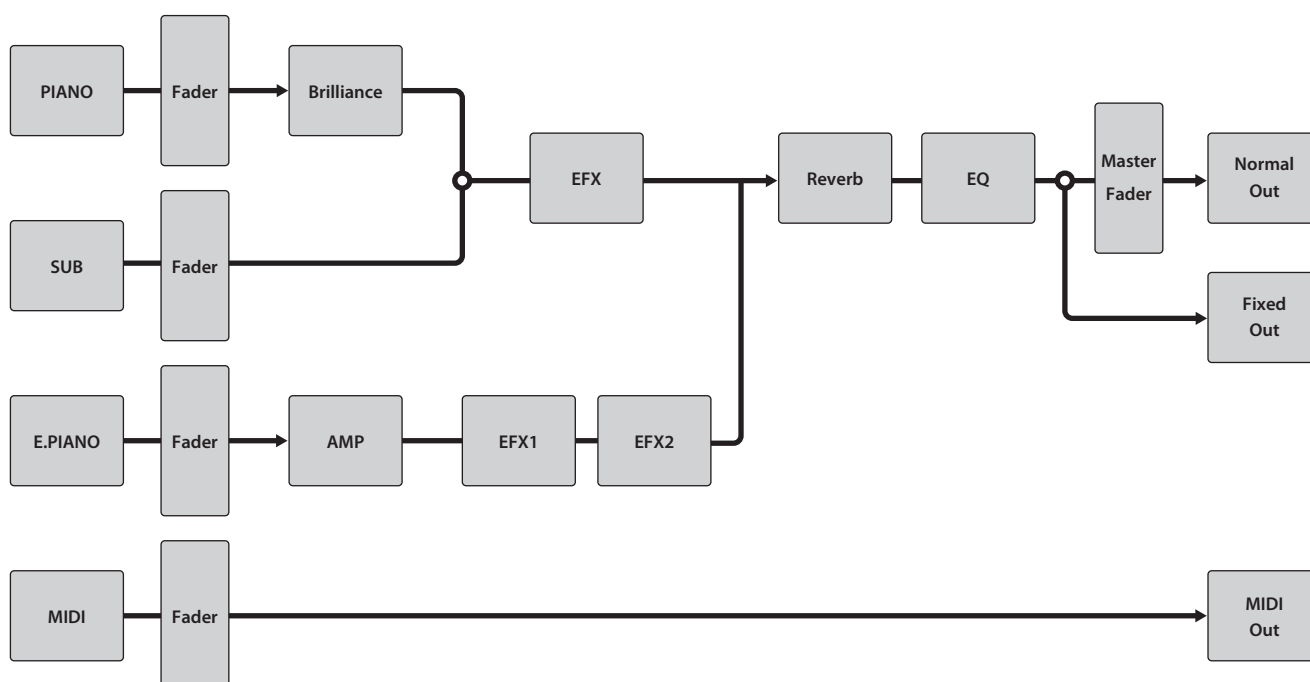

Overview of Internal Sections

1 Section Basics

As noted previously, the MP10's PIANO, E.PIANO, and SUB sections all share largely the same operation. This page will explain the fundamentals of turning sections ON and OFF, selecting sounds, and adjusting the section volume.

■ Turning a section ON/OFF

Press the ON/OFF button to turn each section ON/OFF.

The LED indicator for the ON/OFF button will turn ON or OFF to indicate the current status of the section.

Section OFF



ON/OFF



Section ON



ON/OFF

■ Selecting sounds

For example: selecting the Jazz Grand 2 piano sound.

Turn the PIANO section ON and all other sections OFF.

Press the JAZZ category button, then press the 2 variation button to select the Jazz Grand 2 piano sound.

The LED indicators for the category and variations buttons will turn ON to indicate that they are currently selected, and the variation list will pop-up in the LCD display.

Play the piano.

The Jazz Grand 2 piano sound will be heard.



JAZZ



2

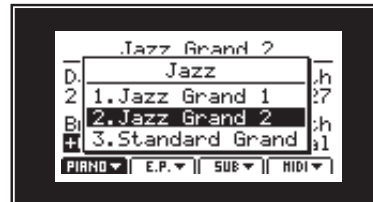

■ Adjusting the section volume

Use the VOLUME fader below each section's ON/OFF button to adjust the volume of the section.

The volume of the section will increase or decrease independently of the other sound sections.

To adjust the volume of all sound sections simultaneously, use the MASTER VOLUME fader (page 10).

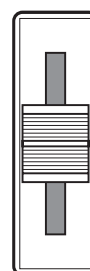

Increase volume

Decrease volume



2 LCD Display & Control Knobs

In regular Play Mode the LCD display provides a visual indication of the selected section and sound, and the values of the four real-time control knobs (A, B, C, and D).

The function of each knob can be assigned to control any parameter in the EDIT menu, allowing frequently used functions to be accessed from a single screen. Furthermore, two groups of knob parameters (2 x 4) can be defined for each of the PIANO, E.PIANO, SUB, and MIDI sections, providing extensive control over the selected sounds.

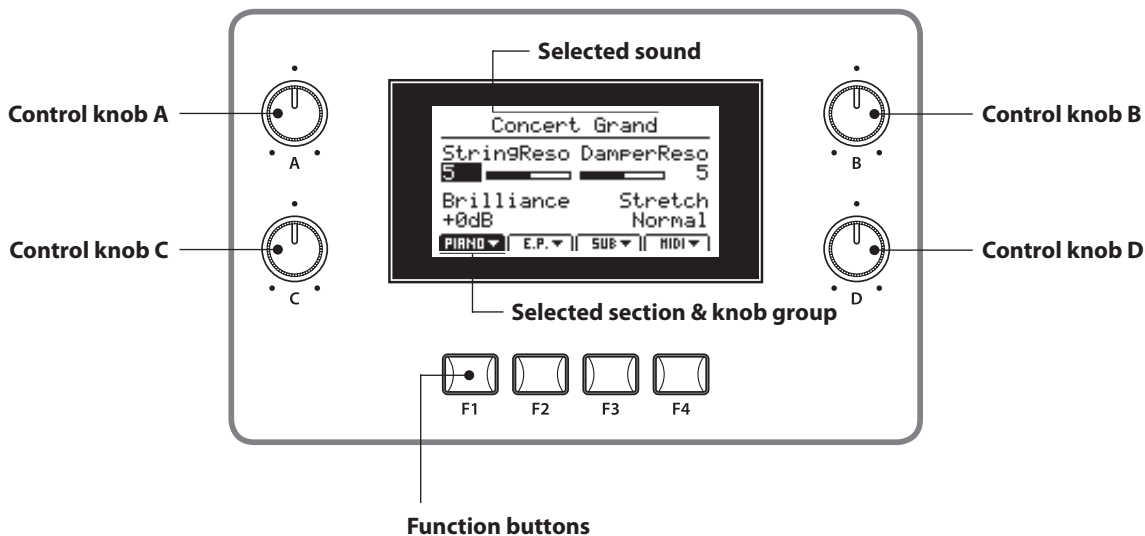

Selecting sections, primary/secondary knob groups

Press the function buttons (F1, F2, F3, and F4) located below the LCD display to select the desired section.

The section icon will become highlighted, and the name of the selected sound and primary group of knob parameters will be shown in the LCD display.

Press the same function button two times to show the secondary group of knob parameters in the LCD display.

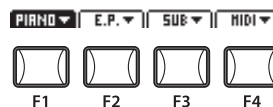

Adjusting parameters

Turn the four control knobs (A, B, C, D) located on either side of the LCD display to adjust the displayed knob group parameters.

- * Numeric parameters can typically be adjusted within the range of 0-127.
- * EDIT menu parameters can be freely assigned to each of the four knobs in the Knob Assign page of the EDIT menu (page 43).

Parameters can also be adjusted by using the CURSOR buttons to move the selection cursor, and -/NO or +/YES buttons to decrease or increase the value of the selected parameter.

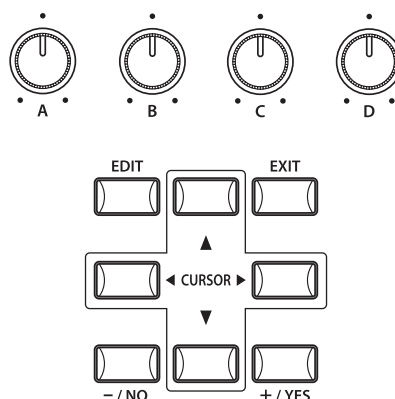

3 Reverb

Reverb adds reverberation to the sound, simulating the acoustic environment of a recital room, stage, or concert hall. The MP10 features 7 high quality types of reverb.

Each sound section features independent REVERB ON/OFF and REVERB DEPTH controls, however the REVERB TYPE (and associated settings) is common to all sections.

■ Turning reverb ON/OFF

Press the desired sound section's REVERB button to turn the reverb for that section ON/OFF.

The LED indicator for the sound section's REVERB button will turn ON or OFF to indicate the current status of the reverb.

Reverb OFF



REVERB



Reverb ON



REVERB

■ Adjusting the reverb depth

Ensure that reverb is turned ON for the desired sound section.

Turn the section's REVERB DEPTH knob to adjust the depth of the reverb for that section.

The REVERB DEPTH value will pop-up briefly in the LCD display.

* The REVERB DEPTH can be adjusted within the range of 0-127.

* The global reverb depth can be offset using the Reverb Offset setting in the Offset page of the SYSTEM menu (page 74), or by pressing and holding the REVERB button then turning the DEPTH knob.



DEPTH



■ Changing the reverb type and additional parameters

Ensure that reverb is turned ON for the desired sound section.

Press and hold the section's REVERB button.

The Reverb page of the EDIT menu will be shown in the LCD display.

Turn the four control knobs (A, B, C, D) to change the reverb type and adjust additional reverb parameters.

Press and hold the REVERB button again to exit.



REVERB

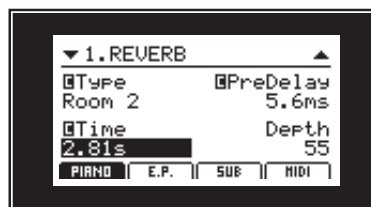

■ Reverb parameters

Knob	Parameter	Value
A	Type	Hall, Stage, Room, Plate
B	PreDelay	0 - 101.6ms
C	Time	300ms - 8.0s (depending on type)
D	Depth	0 - 127

■ Reverb types

Reverb type	Description
Hall 1	Simulates the ambiance of a concert hall.
Hall 2	Simulates the ambiance of a small theater.
Stage 1	Simulates the ambiance of a large live stage.
Stage 2	Simulates the ambiance of a smaller live stage.
Room 1	Simulates the ambiance of a rehearsal room.
Room 2	Simulates the ambiance of a living room.
Plate	Simulates the ambiance of a metallic plate.

4 EFX

In addition to reverb, various other effects can be applied to the selected sound, altering the tonal character and feeling of the instrument. The MP10 features 25 high quality EFX types, with an effect assigned to each sound by default.

The PIANO and SUB sound sections share one common effect module, while the E.PIANO section features two separate effects modules that can be connected in series.

■ Turning EFX ON/OFF

Press the desired sound section's EFX button to turn the effects for that section ON/OFF.

The LED indicator for the sound section's EFX button will turn ON or OFF to indicate the current status of the effects.

* The E.PIANO section's EFX1 and EFX2 modules are turned ON and OFF in exactly the same way.

Effects OFF



EFX



Effects ON



EFX

■ Changing the effects type and additional parameters

Ensure that effect(s) are turned ON for the desired sound section.

Press and hold the section's EFX button.

The EFX page of the EDIT menu will be shown in the LCD display.

Turn the four control knobs (A, B, C, D) to change the effect type and adjust additional parameters.

Press and hold the EFX button again to exit.



EFX

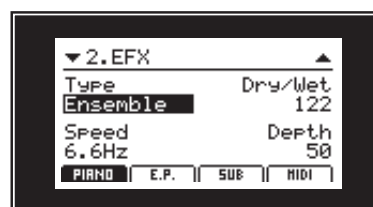

■ Effect types

Effect type	Description
Chorus 1	Layers a slightly detuned version of the sound over the original, thus enriching its tonal character.
Chorus 2	Similar in principle to Chorus 1, however the effect utilises a triangular wave.
Flanger 1	Introduces a shifting comb-filter to the sound, producing in a hollow tone with a sense of motion.
Flanger 2	Similar in principle to Flanger 1, however the effect utilises a triangular wave.
Celeste	A three part chorus, with each of the chorus units set at different levels of phase.
Ensemble	Similar in principle to Celeste, but with each chorus unit also set at different frequencies for a slightly richer effect.
Ping Delay	Adds a basic 'ping pong' echo effect to the sound, giving the impression that it is 'bouncing' from left to right.
Triple Delay	Similar in principle to Ping Delay, but with an additional level of echo.
Fast Delay	Similar in principle to Ping Delay, but with a faster echo velocity.
Slow Delay	Similar in principle to Ping Delay, but with a slower echo velocity.
A.Pan Sine	Alternates the sound output from left to right across the stereo field using a sine wave.
A.Pan Sq. 1	Similar in principle to A. Pan Sine, however the effect utilises a square wave.
A.Pan Sq. 2	Similar in principle to A. Pan Sq 2, however the effect utilises an additional overdrive effect.

Continues on the following page.

Overview of Internal Sections

■ Effect types (cont.)

Continued from the previous page.

Effect type	Description
Trem. Sine	Increases and decreases the volume of the sound at a variable rate using a sine wave.
Trem. Sq. 1	Similar in principle to Trem. Sine, however the effect utilises a square wave.
Trem. Sq. 2	Similar in principle to Trem. Sq. 1, however the effect utilises an additional overdrive effect.
Trem. Saw	Similar in principle to Trem. Sine, however the effect utilises a saw wave.
Phaser 1	Applies a cyclic phase change to the sound, giving the impression that the sound is moving.
Phaser 2	Similar in principle to Phaser 1, however the effect is more suitable for sounds with fewer harmonics.
Rotary 1	Simulates the sound of the rotary speaker cabinet commonly used with electronic organs.
Rotary 2	Similar in principle to Rotary 1, however the effect utilises an additional overdrive effect.
Auto Wah	Creates an automatic filter sweep at the attack of each note.
Pedal Wah	Creates a manual filter sweep using a connected expression pedal (page 14).
Enhancer	Produces a crisper tone, resulting in a more discernible sound.
Overdrive	Adds tube amp-style distortion to the sound.

■ Effect parameters

Knob A: Type	Knob B: Parameter 1		Knob C: Parameter 2		Knob D: Parameter 3	
Chorus1	Dry / Wet	0 - 127	Speed	0 - 12.7Hz	Depth	0 - 127
Chorus2	Dry / Wet	0 - 127	Speed	0 - 12.7Hz	Depth	0 - 127
Flanger1	Dry / Wet	0 - 127	Speed	0 - 12.7Hz	Depth	0 - 127
Flamger2	Dry / Wet	0 - 127	Speed	0 - 12.7Hz	Depth	0 - 127
Celeste	Dry / Wet	0 - 127	Speed	0 - 12.7Hz	Depth	0 - 127
Ensemble	Dry / Wet	0 - 127	Speed	0 - 12.7Hz	Depth	0 - 127
Ping Delay	Wet Level	0 - 127	Delay time	0 - 743ms	Feedback	0 - 127
Triple Delay	Wet Level	0 - 127	Delay time	0 - 743ms	Feedback	0 - 127
Fast Delay	Wet Level	0 - 127	Delay time	0 - 372ms	Feedback	0 - 127
Slow Delay	Wet Level	0 - 127	Delay time	0 - 743ms	Feedback	0 - 127
A.Pan Sine	Depth	0 - 127	Speed	0 - 12.7Hz	-	-
A.Pan Sq. 1	Depth	0 - 127	Speed	0 - 12.7Hz	-	-
A.Pan Sq. 2	Depth	0 - 127	Speed	0 - 12.7Hz	Drive	0 - 127
Trem. Sine	Depth	0 - 127	Speed	0 - 12.7Hz	-	-
Trem. Sq. 1	Depth	0 - 127	Speed	0 - 12.7Hz	-	-
Trem. Sq. 2	Depth	0 - 127	Speed	0 - 12.7Hz	Drive	0 - 127
Trem. Saw	Depth	0 - 127	Speed	0 - 12.7Hz	-	-
Phaser 1	Dry / Wet	0 - 127	Speed	0 - 12.7Hz	Depth	0 - 127
Phaser 2	Dry / Wet	0 - 127	Speed	0 - 12.7Hz	Depth	0 - 127
Rotary 1	Dry / Wet	0 - 127	Speed	Slow / Fast	Acceleration	0 - 127
Rotary 2	Drive	0 - 127	Speed	Slow / Fast	Acceleration	0 - 127
Auto Wah	Dry / Wet	0 - 127	Sense	0 - 127	-	-
Pedal Wah	Dry / Wet	0 - 127	Sense	0 - 127	-	-
Enhancer	Wet Level	0 - 127	Intensity	0 - 127	-	-
Overdrive	Level	0 - 127	Drive	0 - 127	-	-

5 Amp Simulator (E.PIANO section only)

The tonal character of an amplifier or speaker cabinet is an important component of vintage electric piano sounds. The MP10's Amp Simulator function features 6 typical amplifier types, each with drive, level, and 3-band EQ parameters.

Turning the Amp Simulator ON/OFF

Press the E.PIANO sound section's AMP button to turn the amp simulator ON/OFF.

The LED indicator for the AMP button will turn ON or OFF to indicate the current status of the amp simulator.

Amp Sim OFF



AMP



Amp Sim ON



AMP

Adjusting the Amp Simulator drive

Ensure that the amp simulator is turned ON.

Turn the E.PIANO sound section's AMP DRIVE knob to adjust the drive level of the amp simulator.

The AMP DRIVE value will pop-up briefly in the LCD display.

* The AMP DRIVE can be adjusted within the range of 0-127.



Changing the Amp type and additional parameters

Ensure that the amp simulator is turned ON.

Press and hold the E.PIANO sound section's AMP button.

The first Amp Simulator page of the EDIT menu will be shown in the LCD display.

Turn the control knobs A, B, and C to change the amp type, and adjust the drive, and level parameters.

Press the CURSOR ▼ button to show the second Amp Simulator page, then turn the control knobs A, B, and C to adjust the 3-band AmpEQ parameters.

Press and hold the AMP button again to exit.

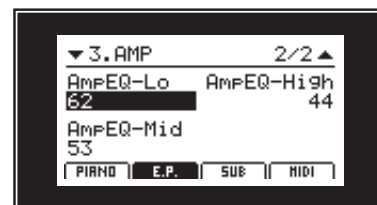
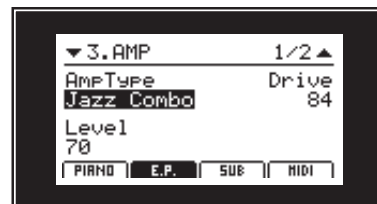

Amp Simulator parameters

page 1:

Knob	Parameter	Description
A	AmpType	Jazz Combo, Tweed Deluxe, etc.
B	Drive	The drive level of the amplifier.
C	Level	The volume level of the amplifier.

page 2:

Knob	Parameter	Description
A	AmpEQ-Lo	The Low freq. level of the amplifier.
B	AmpEQ-Mid	The Mid freq. level of the amplifier.
C	AmpEQ-Hi	The High freq. level of the amplifier.

* For more detailed information about the Amp Simulator parameters, please refer to page 25.

Internal Sections & Feature Parameters

1 PIANO section

The MP10's PIANO section features nine different grand piano sounds arranged into CONCERT, POP, and JAZZ categories. Each piano sound has been sampled from the Kawai EX Concert grand piano with alternate voicing configurations, microphone positions, and recording techniques, providing a strong selection of distinctive grand piano sounds that are suitable for various musical styles.

PIANO section sounds

	No.	Sound Name	Description
CONCERT	1	Concert Grand	A rich and dynamic concert grand piano.
	2	Studio Grand	A clear and powerful concert grand piano.
	3	Mellow Grand	A soft and warm concert grand piano.
POP	1	Pop Piano	A clear and vibrant pop grand piano.
	2	Bright Pop Piano	A sharp and bright pop grand piano.
	3	Mellow Pop Piano	A soft and warm pop grand piano.
JAZZ	1	Jazz Grand 1	A warm, powerful grand piano sound with a vintage jazz character.
	2	Jazz Grand 2	A brighter grand piano sound with a more modern jazz and fusion character.
	3	Standard Grand	The popular Concert Grand piano sound from the MP8II.

An experienced piano technician is essential to fully realise the potential of a fine acoustic piano. In addition to meticulously tuning each note, the technician also performs numerous regulation and voicing adjustments that allow the instrument to truly sing.

The PIANO section's Virtual Technician parameters simulate these refinements digitally, allowing performers to shape various aspects of the piano sound's character to suit their personal preferences.

Adjusting Virtual Technician parameters

Press the EDIT button to show the EDIT menu in the LCD display.

EDIT



Press the F1 function button to select the PIANO section, then the CURSOR ▼ button to select VirtTech. Finally, press the +/- YES button to enter the Virtual Technician parameter pages.

Turn the control knobs A, B, C, and D to adjust each parameter. Press the EXIT button to return to the main EDIT menu.



Virtual Technician parameters

Parameter name	Description
Voicing	Adjust the tonal character of the selected piano sound.
Stereo Width	Adjust the stereo width of the selected piano sound.
String Resonance	Adjust the resonance that is heard when notes are held.
Damper Resonance	Adjust the resonance that is heard when depressing the damper pedal.
Key-off Effect	Adjust the volume of the sound that is heard when keys are released.
Damper Noise	Adjust the volume of the sound that is heard when depressing the damper pedal.
Hammer Delay	Adjust the delay of the hammer striking strings when playing pianissimo.
Fall Back Noise	Adjust the volume of the sound that is heard when the key action falls back.
Brilliance	Adjust the brightness of the overall piano sound.

2 E.PIANO section

The MP10's E.PIANO section features nine different electric piano sounds arranged into TINE, REED, and OTHERS categories. Each electric piano sound has been lovingly sampled from original, vintage instruments (complete with imperfections), and can be enjoyed in their 'organic' form, or with analogue effects and speaker simulations applied for added warmth and character.

■ E.PIANO section sounds

	No.	Sound Name	Description
TINE	1	Tine EP 1	A suitcase-type vintage tine electric piano.
	2	Tine EP 2	A suitcase-type vintage tine electric piano modified for a brighter, harder sound.
	3	Tine EP 3	A stage-type vintage tine electric piano.
REED	1	Reed EP 1	A highly playable vintage reed electric piano.
	2	Reed EP 2	A bright vintage reed electric piano.
	3	Reed EP 3	A warm vintage reed electric piano.
OTHERS	1	Modern EP	An FM type electric piano.
	2	Clavi 1	A funky keyboard sound with electric pick-ups
	3	Clavi 2	A natural, fatter sounding Clavi sound.

The tonal character of an amplifier or speaker cabinet is an important component of vintage electric piano sounds. For this reason, the E.PIANO section features a dedicated Amp Simulator function consisting of 6 typical amplifier cabinets, each with drive, level, and 3-band EQ parameters.

■ Adjusting Amp Simulator parameters

In addition to the process explained on page 23, the following method can also be used to adjust Amp Simulator parameters.

Press the EDIT button to show the EDIT menu in the LCD display.

Press the F2 function button to select the E.PIANO section, then the CURSOR ▼ button to select AMP. Finally, press the +/YES button to enter the Amp Simulator parameter pages.

Turn the control knobs A, B, C, and D to adjust each parameter.

Press the EXIT button to return to the main EDIT menu.

EDIT

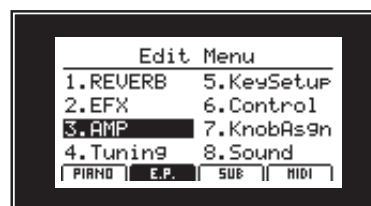

■ Amp types

Amp type	Description
Jazz Combo	Typical transistor combo amp.
Tweed Deluxe	60's vintage type, suitable for a clean sound.
Tweed Bass	4 x 10" speaker combo type for bass sound.
British Blues	Suitable for crunch drive sound.
UK Class A	For a growling, overdriven sound.
Tube Pre Amp	Typical pre amp for keyboards.

* The Key-off Noise and Key-off Delay parameters in the Key Setup EDIT menu can also be used to adjust the E.PIANO section's sound (page 40).

3 SUB section

The MP10's SUB section features nine additional 'subsidiary' sounds arranged into STRINGS, PAD, and OTHERS categories. These sounds are suitable for layering with PIANO or E.PIANO section sounds, but can of course be played independently if desired.

■ SUB section sounds

	No.	Sound Name	Explanation
STRINGS	1	Hybrid Strings	A mix of natural and synthetic strings.
	2	Hybrid Ensemble	A mix of natural and synthetic strings, with a thicker texture.
	3	Beautiful Str.	A slow, warm natural strings with fine treble.
PAD	1	Pad 1	A typical synth pad.
	2	Pad 2	A typical synth pad, with a warmer character.
	3	String Pad	A typical synth strings pad with fine texture.
OTHERS	1	Vibraphone	A natural vibraphone.
	2	Harpichord	A classical harpichord.
	3	Choir Ooh/Aah	A human choir.

The SUB section contains two feature parameters, Sweep and Bell, that can be used to add a common motion or attack layer to the selected sound.

■ Adjusting SUB section feature parameters

Press the EDIT button to show the EDIT menu in the LCD display.

EDIT



Press the F3 function button to select the SUB section, then the CURSOR ▼ button to select Layer. Finally, press the +/YES button to enter the SUB section's Layer parameters page.

Turn the control knobs A, B, C, and D to adjust each parameter.

Press the EXIT button to return to the main EDIT menu.

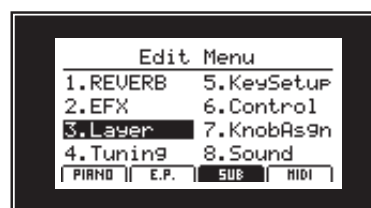

■ SUB section parameters

Parameter	Description
Sweep	Adds a metallic motion layer to the selected sound.
Bell	Adds a bell attack layer to the selected sound.

■ SUB section EFX limitations

As noted in the Introduction chapter (page 17), the PIANO section and SUB section share one EFX module. When the EFX for the PIANO and SUB sections are both turned ON simultaneously, the PIANO section's EFX parameters will have priority.

In this case, the EFX page of the SUB section's EDIT Menu will be temporarily disabled, and the LED indicator for the SUB section's EFX button will also turn green.

EQ Section

The EQ section consists of a 3-band graphic equaliser that can be used to shape the overall tone of the MP10's internal sound sections. In addition, the mid-range frequency can also be adjusted as a parametric equaliser. The equaliser setting is common to all sounds sections.

■ Turning EQ ON/OFF

Press the EQ ON/OFF button to turn the equaliser ON/OFF.

The LED indicator for the EQ ON/OFF button will turn ON or OFF to indicate the current status of the equaliser.

Equaliser OFF



ON/OFF



Equaliser ON



ON/OFF

■ Adjusting EQ parameters

Turn the LO, MID, and HI knobs to adjust each equaliser band.
Turn the FREQ knob to adjust the frequency of the mid-range EQ.

The equaliser screen will be shown in the LCD display, with knob adjustments influencing the LO, MID, and HI levels, and mid-range frequency.

- * The LO, MID, and HI levels can be adjusted within the range of -9 - +9 dB.
- * The mid-range FREQ can be adjusted within the range of 355 - 2500 Hz.

The display will return to the Play Mode screen after a few seconds of inactivity.

To check the equaliser screen without adjusting the EQ knobs, press and hold the EQ ON/OFF button.

- * The EQ section levels can be offset using the EQ Offset setting in the Offset page of the SYSTEM menu (page 74), or by pressing and holding the EQ button then turning the LO/MID/HI knobs.

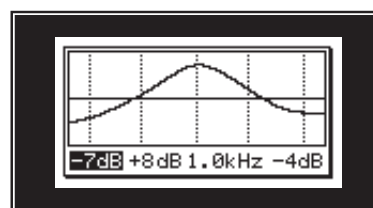
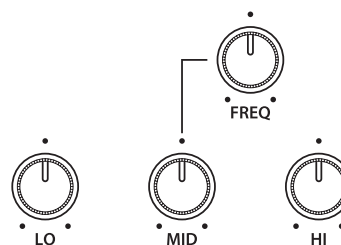

Additional Functions

1 Metronome

The Metronome function provides a steady beat to aid practicing the piano at a consistent tempo. In addition to regular metronome beats, the MP10 also features a variety of drum rhythms to accompany most playing styles and musical genres.

■ Activating the Metronome function

Press the METRONOME button.

The LED indicator for the METRONOME button will turn ON to indicate that the Metronome function is in use.

The Metronome screen will be shown in the LCD display.

Metronome
Deactivated



Metronome
Activated



■ Starting/Stopping the Metronome: Click mode

Press the F1 function button (CLICK), then press the F3 function button (LISTEN).

The LISTEN icon will become highlighted and the metronome will start counting a 4/4 beat at 120 bpm.

Press the F3 button (LISTEN) again.

The metronome will stop counting.

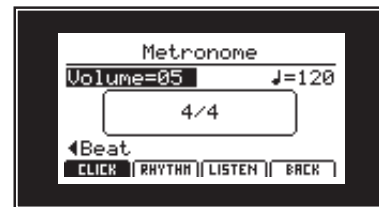

Metronome:
Stop counting



Metronome:
Start counting



■ Adjusting the Metronome volume, tempo, and time signature (beat)

Press the F3 function button to start the metronome counting.

Turn control knobs A and B to adjust the metronome volume and tempo, and knob C to change the time signature (beat).

* The metronome tempo can be adjusted within the range of 30-300 bpm (60-600 bpm for eighth note rhythms).

* There are ten different types of beat/time signature available: 1/4, 2/4, 3/4, 4/4, 5/4, 3/8, 6/8, 7/8, 9/8, and 12/8.

Press the F4 function button (BACK) to return to the Play Mode screen without stopping or deactivating the metronome.

* Press and hold the METRONOME button again to show the Metronome screen in the LCD display.

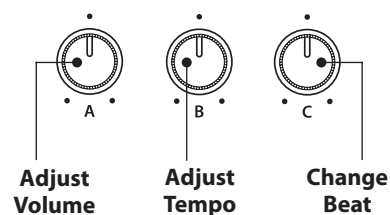

* The selected metronome/drum rhythm settings can be saved to SETUP/POWERON memory.

■ Deactivating the Metronome function

Press the METRONOME button.

The LED indicator for the METRONOME button will turn OFF to indicate that the Metronome function is no longer in use, and the normal play screen will be shown in the LCD display.

* If the metronome is counting it will stop.

Metronome
Activated



Metronome
Deactivated



■ Starting/Stopping the Metronome: Rhythm mode

Press the F2 function button (RHYTHM). The RHYTHM icon will become highlighted to indicate that Rhythm mode is selected. Then press the F3 function button (LISTEN).

The LISTEN icon will become highlighted and the metronome will start playing the Funk Shuffle 1 drum rhythm at 120 bpm.

Press the F3 button (LISTEN) again.

The metronome will stop playing the drum rhythm.

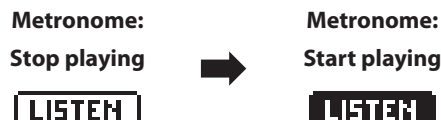
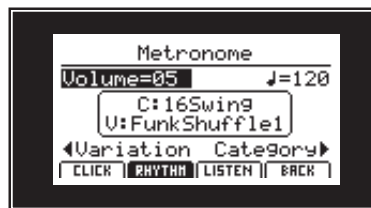

■ Changing the Rhythm category and variation

Press the F3 function button to start the metronome playing a drum rhythm.

Turn control knobs C and D to change the drum rhythm variation and category.

* The selected metronome/drum rhythm settings can be saved to SETUP/POWER ON memory.

* For a full list of Rhythm categories/variations, please refer to page 77.

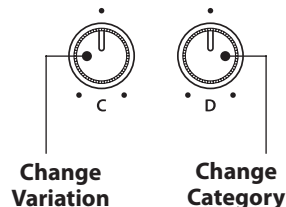

2 Panel Lock

The Panel Lock function temporarily locks most of the MP10's panel functionality, thus preventing accidental button pushes and parameter adjustments.

■ Turning Panel Lock ON/OFF

Press the PANEL LOCK button to turn Panel Lock ON/OFF.

The LED indicator for the PANEL LOCK button will turn ON or OFF to indicate the current status of the Panel Lock function. A brief prompt will also be shown in the LCD display.

When Panel Lock is turned ON, all panel operations will be locked except for the keyboard, pitch bend/modulation wheels, foot controllers, and the PANEL LOCK button itself.

* The Panel Lock functionality can be selected in the Utility page of the SYSTEM menu (page 74).

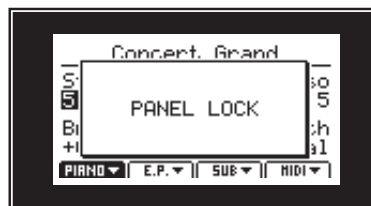

3 Transpose

The Transpose function allows the pitch of the MP10's keyboard to be raised or lowered in semi-tone steps. This is particularly useful when accompanying instruments with different tones, or when a song learned in one key must be played in another key. When transposed, the song can be played in the original key, yet heard in a different key.

■ Showing the Transpose value

Press and hold the TRANSPOSE button.

The current TRANSPOSE value will pop-up briefly in the LCD display.

The default value, 0, indicates no transposition.

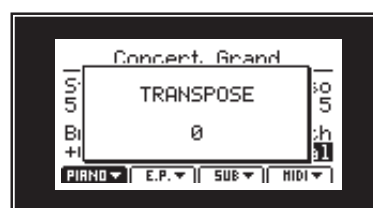

■ Setting the Transpose value: Method 1

Press and hold the TRANSPOSE button, then press the -/NO or +/YES buttons to decrease or increase the value of the transpose function in semi-tone steps.

* The TRANSPOSE value can be adjusted within the range of -24 - +24.

The LED indicator for the TRANSPOSE button will turn ON to indicate that Transpose is in use.

* To reset the transpose value to 0 (no transposition), press both the -/NO and +/YES buttons simultaneously.

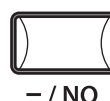

■ Setting the Transpose value: Method 2

Press and hold the TRANSPOSE button, then press a key on the keyboard to the left or right of middle C.

The pressed key will become the new transpose key.

* The TRANSPOSE value can be adjusted within the range of -24 - +24.

The LED indicator for the TRANSPOSE button will turn ON to indicate that Transpose is in use.

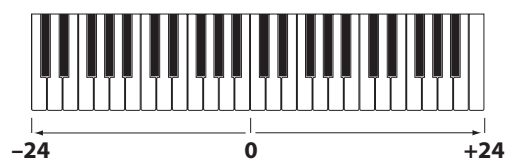

■ Turning Transpose ON/OFF

Press the TRANSPOSE button (without holding) to turn the transpose function ON/OFF.

The LED indicator for the TRANSPOSE button will turn ON or OFF to indicate the current status of the transpose function.

* The previous transpose setting will be remembered after the transpose function is turned OFF, allowing rapid adjustment of the keyboard pitch.

Transpose OFF

Transpose ON

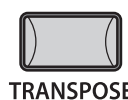

MIDI Section

The basic operation of the MP10's MIDI section is similar to that of the PIANO, E.PIANO, and SUB internal sections. It features an ON/OFF button and a dedicated VOLUME fader, however, instead of controlling internal sounds, this section is used to control external MIDI devices.

■ Turning the MIDI section ON/OFF

Press the MIDI section's ON/OFF button to the section ON/OFF.

The LED indicator for the ON/OFF button will turn ON or OFF to indicate the current status of the section.

When the MIDI section is turned ON, keyboard and pedal events will be sent on the selected MIDI Transmit channel via the MP10's MIDI jacks or USB to Host connector.



■ Selecting the MIDI Transmit Channel

Press the MIDI CH ▲ and MIDI CH ▼ buttons to increase or decrease the MIDI Transmit channel.

* The MIDI CH can be adjusted within the range of 1-16.

The MP10's MIDI Transmit channel must match the MIDI Receive channel of any connected devices.



■ Using the panel to send MIDI control change messages

Use the VOLUME fader below the ON/OFF button to send the CC#07 volume message.

Turn control knobs A, B, C, and D to send the control change messages assigned in the Program page of the EDIT menu (page 45).



■ Using the RECORDER CONTROL buttons to send MMC messages

Press the TRANSPORT button.

The LED indicator for the TRANSPORT button will turn ON to indicate that the RECORDER CONTROL buttons are set to send MMC messages to an external MIDI device.

Press the RECORDER CONTROL buttons to send MMC messages to an external MIDI device.

* The function of each RECORDER CONTROL button can be assigned in the MMC page of the MIDI EDIT menu (page 46).

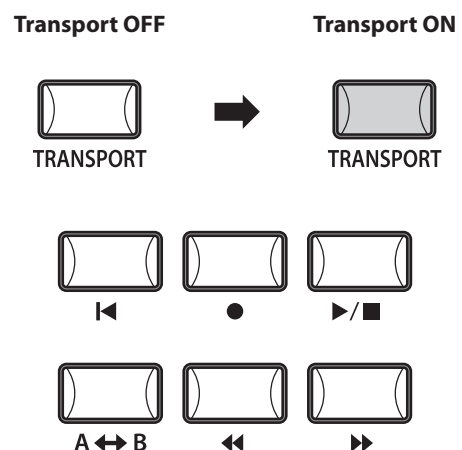

MIDI Section

LOCAL OFF button

Press the LOCAL OFF button to disable the connection between the MP10's keyboard and internal tone generator.

The LED indicator for the LOCAL OFF button will turn ON or OFF to indicate the current status of the LOCAL OFF function.

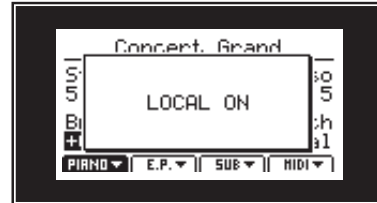

PANIC button

The PANIC button returns all internal sounds to their default PowerOn setting, and also sends the AllNoteOff and ResetAll Controller MIDI messages to any connected devices (1 - 16 ch).

This is a useful function to be used in emergency situations.

* In order to prevent accidental button pushes, the PANIC button must be held for approximately 1 second.

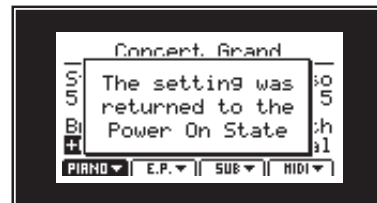

MIDI Implementation

Please refer to the MIDI Implementation section in the Appendix chapter (page 79).

USB MIDI (USB to Host connector)

The MP10 features a 'USB to Host' type connector, allowing the instrument to be connected to a computer and utilised as a MIDI device. Depending on the type of computer and operating system installed, additional driver software may be required for USB MIDI communication to function correctly.

■ USB MIDI driver

Operating System	USB MIDI Driver Support
Windows ME Windows XP (no SP, SP1, SP2, SP3) Windows XP 64-bit Windows Vista (SP1, SP2) Windows Vista 64-bit (SP1, SP2) Windows 7 Windows 7 64-bit	<p>Additional USB MIDI driver software NOT required.</p> <p>The standard (built-in) Windows USB MIDI driver will be installed automatically when the instrument is connected to the computer.</p> <p>* After driver installation, ensure that the 'USB Audio Device' (Windows ME/Windows XP) or 'USB-MIDI' (Windows Vista/Windows 7) device is correctly selected in the application software.</p>
Windows 98 SE Windows 2000 Windows Vista (no SP)	<p>Additional USB MIDI driver software required.</p> <p>Please download the USB MIDI driver from the KAWAI website: → http://www.kawai.co.jp/english</p> <p>* After driver installation, ensure that the 'KAWAI USB MIDI' device is correctly selected in the application software.</p>
Windows Vista 64-bit (no SP)	<p>USB MIDI is not supported.</p> <p>Please upgrade to service pack 1 or service pack 2.</p>
Mac OS X	<p>No additional USB MIDI driver software required.</p> <p>The standard (built-in) Mac OS X USB MIDI driver will be installed automatically when the instrument is connected to the computer.</p>
Mac OS 9	<p>USB MIDI is not supported.</p> <p>Please use the standard MIDI IN/OUT connectors.</p>

■ USB MIDI information

- If the instrument's MIDI IN/OUT jacks and USB MIDI port are both connected simultaneously, the USB MIDI port will be given priority.
- Ensure that the instrument is turned OFF before attempting to connect the USB MIDI cable.
- When connecting the instrument to a computer using the USB MIDI port, there may be a short delay before communications begin.
- If the instrument is connected to a computer via a USB hub and USB MIDI communication becomes unreliable/unstable, please connect the USB MIDI cable directly to the one of the computer's USB ports.
- Disconnecting the USB MIDI cable suddenly, or turning the instrument on/off while using USB MIDI may cause computer instability in the following situations:
 - while installing the USB MIDI driver
 - while starting up the computer
 - while MIDI applications are performing tasks
 - while the computer is in energy saver mode
- If there are any further problems experienced with USB MIDI communication while the instrument is connected, please double-check all connections and relevant MIDI settings in the computer's operating system.

* 'MIDI' is a registered trademark of the Association of Manufacturers of Electronic Instruments (AMEI).

* 'Windows' is registered trademark of Microsoft Corporation.

* 'Macintosh' is registered trademark of Apple Computer, Inc.

* Other company names and product names mentioned referenced herein may be registered trademarks or trademarks of respective owners.

Overview of the EDIT Menu

The EDIT menu contains various parameters that can be used to adjust the MP10's sound and MIDI sections. The parameters are grouped by category, allowing close control over the instrument with just a few button presses.

This collection of parameters, together with other adjustable settings, can be stored as a SETUP memory (page 50). The MP10 provides 26 banks x 6 setups, for a total of 156 user programmable setup memories.

PIANO, E.PIANO, SUB parameters

Page No.	Category	Parameters
1	REVERB	Type, Pre Delay, Time, Depth
2	EFX	Type, Parameters (depends on EFX type)
3	VirtTech (PIANO)	Voicing, Stereo Width, String Resonance, Damper Resonance, Key-off Effect, Damper Noise, Hammer Delay, Fall Back Noise, Brilliance
	AMP (E.PIANO)	Amp Type, Drive, Level, Amp EQ
	Layer (SUB)	Sweep, Bell
4	Tuning	Fine Tune, Stretch Tuning, Temperament, Key of Temperament
5	KeySetup	Touch Curve, Octave Shift, KS-Damping/KS-Key, Split/Split Point, Key Off Noise (E.PIANO), Key Off Delay (E.PIANO), Dynamics (SUB)
6	Control	Damper Pedal, Damper Pedal Mode, Left Pedal, Left Pedal Assign, Pitch Bend, Bend Range, Modulation Wheel, Modulation Wheel Assign, Expression Pedal, Expression Pedal Assign, Foot SW, Foot SW Assign
7	KnobAsgn	n/a
8	Sound	Attack Time, Decay Time, Sustain Level, Release Time, Filter Resonance, Filter Cut-Off, Panpot, Volume

Unless stated, parameter settings for the PIANO, E.PIANO, and SUB sound sections are independent for each section. Parameters marked with a  icon are common for all three sections.

MIDI parameters

Page No.	Category	Parameters
1	Program	Program, Bank MSB/LSB
2	Transmit (SYSTEM)	Send Program, Send Bank, Send Volume, Send Knobs, Transmitting Recorder
3	Receive (SYSTEM)	Receive Mode, PIANO Channel, E.PIANO Channel, SUB Channel
4	MMC (SYSTEM)	MMC Dev. ID, MMC Commands
5	KeySetup	Touch Curve, Octave Shift, Split/Split Point, Dynamics, Solo, Transmit
6	Control	Damper Pedal, Left Pedal, Left Pedal Assign, Pitch Bend, Bend Range, Modulation Wheel, Modulation Wheel Assign, Expression Pedal, Expression Pedal Assign, Foot SW, Foot SW Assign
7	KnobAsgn	n/a

Parameters for the MIDI section marked with a  icon are SYSTEM parameters and memorised automatically.

■ Entering the EDIT Menu

Press the EDIT button.

The LED indicator for the EDIT button will turn ON, and the Edit Menu will be shown in the LCD display.



■ Selecting the parameter category

After entering the EDIT Menu:

Press the F1, F2, F3, or F4 function buttons to select the desired section to edit.

Next press the CURSOR buttons then the +/YES button to select and enter the desired parameter category.



■ Adjusting parameters

Turn the four control knobs (A, B, C, D) located on either side of the LCD display to adjust the displayed parameters.

* Numeric parameters can typically be adjusted within the range of 0-127.

Parameters can also be adjusted by using the CURSOR buttons to move the selection cursor, and -/NO or +/YES buttons to decrease or increase the value of the selected parameter.

* Press the CURSOR ▲ or CURSOR ▼ buttons to cycle through the other EDIT Menu categories and pages.

Press the EXIT button to exit the parameter category, or return to the Play Mode screen.

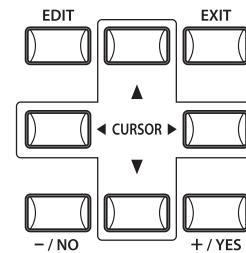
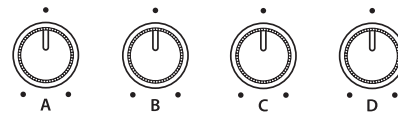

Parameter adjustments made to the selected sound will be lost upon selecting another sound.

* To store the adjusted sound, use the STORE button (page 47).

■ Quick Compare function

The Quick Compare function allows the current, adjusted sound to be compared 'on the fly' with the original stored sound, simply by pressing the selected sound variation button.

For example: reviewing adjustments made to the Jazz Grand 2 piano sound (PIANO section, JAZZ category, variation 2).

Press the 2 variation button.

The LED for the variation button will start to flash, and the keyboard will play the original stored sound.

Press the 2 variation button again.

The LED for the variation button will stop flashing, turn ON, and the keyboard will returning to playing the adjusted sound.

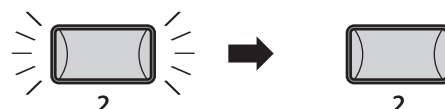
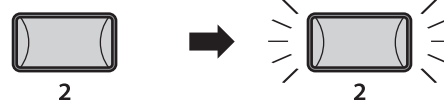
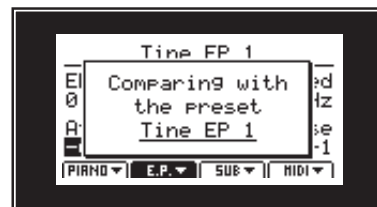

EDIT Menu parameters (PIANO, E.PIANO, SUB)

1 Reverb

1. Type

7 TYPES

This parameter selects the reverb type.

- * For more information about reverb, please refer to page 20.
- * This parameter is common for all three sound sections.
- * This parameter is not stored to SOUND but to SETUP only.

2. Pre Delay

VALUE: 0 - 101.6ms

This parameter adjusts the delay time before the start of the reverberation.

- * For more information about reverb, please refer to page 20.
- * This parameter is common for all three sound sections.
- * This parameter is not stored to SOUND but to SETUP only.

3. Time

VALUE: 300ms - 8.0s

This parameter adjusts the reverb time.

- * For more information about reverb, please refer to page 20.
- * This parameter is common for all three sound sections.
- * This parameter is not stored to SOUND but to SETUP only.

4. Depth

VALUE: 0 - 127

This parameter adjusts the reverb depth, and is also controlled by the REVERB DEPTH knob for each sound section.

- * For more information about reverb, please refer to page 20.

2 EFX

1. Type

25 TYPES

This parameter selects the effect type.

- * For more information about effects, please refer to page 21.
- * The E.PIANO section lists two pages for EFX1 and EFX2.
- * If the EFX for PIANO and SUB sections are both turned ON, the PIANO section's setting has higher priority.

2. Parameters

N/A

These parameters change depending on the selected EFX type, and are used to adjust the mixing amount of the effected (wet) and bypassed (dry) sound, depth, speed, feedback, etc.

- * For more information about effects, please refer to page 21.

3.1 Virtual Technician (PIANO)

1. Voicing

6 TYPES

This parameter attempts to recreate the technique of adjusting the action, hammers and strings of an acoustic piano, allowing the tonal character and dynamics of the MP10's piano sounds to be dramatically enhanced.

Voicing types

Voicing Type	Description
Normal	Produces the normal tone of an acoustic piano throughout the entire dynamic range.
Mellow 1/2	Reproduces the effect of a softer hammer surface for a mellower tone throughout the entire dynamic range.
Dynamic	This setting is not possible with an acoustic piano. Softly played notes will have the tone of a mellow voicing while notes played harder will have the tone of a bright voicing. This setting produces a dramatic change from mellow to bright throughout the entire dynamic range.
Bright 1/2	Produces a brighter tone throughout the entire dynamic range.

2. Stereo Width

VALUE: 0 - 127

This parameter adjusts the width of the stereo sound.

3. String Resonance

VALUE: 0 (OFF) - 10

This parameter adjusts the volume of the string resonance.

String Resonance refers to a phenomenon that exists in acoustic pianos whereby the strings of held notes resonate 'sympathetically' with other notes of the same harmonic series.

4. Damper Resonance

VALUE: 0 (OFF) - 10

This parameter adjusts the volume of the damper resonance.

Depressing the damper pedal of an acoustic piano raises all dampers, allowing the strings to vibrate freely. When a note or chord is played on the piano with the sustain pedal depressed, not only will the strings of the notes played vibrate, but also the strings of other notes, vibrating in sympathetic resonance.

5. Key-off Effect

VALUE: 0 (OFF) - 10

This parameter adjusts the volume of the key-off effect.

When playing an acoustic piano - particularly in the bass region of the keyboard - if a key is played with force and released quickly, it is often possible to hear the faint sound of the damper touching the strings immediately before the vibrations are stopped.

6. Damper Noise

VALUE: 0 (OFF) - 10

This parameter adjusts the volume of the damper noise.

When the damper pedal is depressed and released, it is often possible to hear the sound of the damper head touching and releasing the strings.

7. Hammer Delay

VALUE: 0 (OFF) - 10

This parameter adjusts the delay of the hammer striking the string when playing with pianissimo.

8. Fall-back Noise

VALUE: 0 (OFF) - 10

This parameter adjusts the volume of the noise heard when the keyboard action 'falls back' after a key is released.

9. Brilliance

VALUE: -10 - +10

This parameter adjusts the overall brightness of the piano sound independently of the Voicing parameter.

3.2 Amp Simulator (E.PIANO)

1. Amp Type

6 TYPES

This parameter selects the Amp type.

* For more information about the Amp Simulator, please refer to page 23.

3. Level

VALUE: 0 - 127

This parameter adjusts the volume of the amplifier.

* For more information about the Amp Simulator, please refer to page 23.

2. Drive

VALUE: 0 - 127

This parameter adjusts the amount of overdrive produced by the amplifier, and is also controlled by the E.PIANO section's DRIVE knob.

* For more information about the Amp Simulator, please refer to page 23.

4. Amp EQ

VALUE: 0 - 127

These parameter adjust the HI, MID, and LO frequencies of the amplifier.

* These parameters function independently of the MP10's main EQ controls.

* For more information about the Amp Simulator, please refer to page 23.

3.3 Layer Tone (SUB)

1. Sweep

VALUE: 0 - 127

This parameter adjusts the amount of Sweep pad sound that is added to the selected SUB sound.

2. Bell

VALUE: 0 - 127

This parameter adjusts the amount of Bell pad sound that is added to the selected SUB sound.

4 Tuning

1. Fine Tune

VALUE: -64 - +63

This parameter adjusts the tuning of the selected sound for values smaller than a semi-tone.

2. Stretch Tuning

9 TYPES

This parameter selects the level of stretch tuning.

The human ear typically detects high and low frequencies less accurately than those frequencies within the middle range. The tuning of an acoustic piano is therefore 'stretched' to compensate, ensuring that the sound will be heard more naturally to the ears.

3. Temperament

7 TYPES + 2 USER

This parameter selects the tuning system of the selected sound.

* For more information about Temperaments, please refer to page 39.

* Custom USER temperaments can be created in the User Edit page of the SYSTEM menu (page 75).

4. Key of Temperament

RANGE: C - B

This parameter selects the key of the selected temperament. When using a temperament other than Equal Temperament, use this setting to specify the key signature of the piece.

* This parameter will only affect the 'balance' of the tuning system, the pitch of the keyboard will remain unchanged.

■ Temperament types

Temperament Type	Description
Equal	This is the most popular tuning method that divides the scale into twelve equal semi-tones. This produces the same chordal intervals in all twelve keys, and has the advantage of limitless modulation of the key. However the tonality of each key becomes less characteristic and no chord is in pure consonance
Pure Maj/Min	This temperament, which eliminates dissonances for thirds and fifths is still popular for choral music because of its perfect harmony. When playing in a major key select 'Pure Maj' and when playing in a minor key select 'Pure Min'
Pythagorean	This temperament, which uses mathematical ratios to eliminate dissonance for fifths, is very limited for use with chords, but it produces very characteristic melodic lines.
Meantone	This temperament, which uses a mean between a major and minor whole tone to eliminate dissonance for thirds, was devised to eliminate the lack of consonances experienced with certain fifths for the Mersenne pure temperament. It produces chords that are more beautiful than those with the equal temperament.
Werkmeis/Kirnberg	These two temperaments are placed in between Meantone and Pythagorean. For music with few accidentals, this temperament produces the beautiful chords of the mean tone, but as accidentals increase, the temperament produces the characteristic melodies of the Pythagorean temperament. It is used primarily for classical music written in the Baroque era to revive the original characteristics.
Sys.User1/2	User defined temperament created by raising lor lowering the pitch for each semi-tone.

■ Creating USER temperaments

Please refer to the User Edit explanation in the SYSTEM Menu chapter (page 75).

5 Keyboard Setup

1. Touch Curve

This parameter selects the touch response curve of the keyboard.

* Custom USER touch curves can be created in the User Edit page of the SYSTEM menu (page 74).

Touch curve types

6 TYPES + 2 USER

Touch curve	Description
Heavy+	Requires considerably more striking force to achieve a loud volume.
Heavy	Requires a heavier touch to produce a loud volume. Ideally suited to those with stronger fingers.
Normal	Reproduces the standard touch sensitivity of a typical acoustic piano.
Light	A louder volume is produced even when playing with a soft touch. For those still developing finger strength.
Light +	Requires less striking force to achieve a forte note. For players with a very delicate touch.
Off	A constant volume is produced regardless of how hard the keys are struck.
Sys.User1/2	A custom touch curve, created to suit an individual's personal playing style.

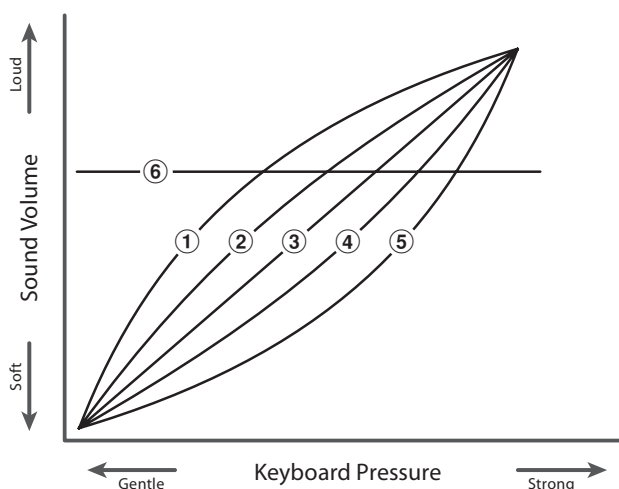

①	Light +
②	Light
③	Normal
④	Heavy
⑤	Heavy +
⑥	Off

2. Octave Shift

-3 - +3 OCTAVES

This parameter sets the amount of octave transposition for the selected section.

3. KS-Damping/KS-Key

ON/OFF, RANGE: A-1 - C7

This function allows the velocity of the keyboard to be reduced over a specified range. This may be useful when layering a piano sound with a strings sound, in order to reduce the level of the strings sound in the higher key range.

The damping key range is from the KS-Key to the highest key.

* This function is not available for the MIDI section.

Creating USER touch curves

Please refer to the User Edit explanation in the SYSTEM Menu chapter (page 74).

4. Split/Split Point

OFF/LOWER/UPPER

This function divides the keyboard into two parts, and allows each of the PIANO, E.PIANO, SUB, and MIDI sections to be assigned to either the upper or lower part. When Split is set to OFF, the selected section will continue to use the entire keyboard.

The Split Point defines the point at which the upper and lower parts are divided, and is a common parameter for all four sections.

- * The Split/Split Point parameters are not stored to SOUND but to SETUP only.
- * The Split Point parameter is common for all three sound sections.
- * When Split is activated (upper or lower), the selected sound section will be turned ON automatically.

5. Key-off Noise (E.PIANO)

VALUE: 0 - 127

This parameter adjusts the volume of the noise heard when the keys of an electromechanical instrument are released.

- * This parameter is only available for the E.PIANO section.

6. Key-off Delay (E.PIANO)

VALUE: 0 - 127

This parameter adjusts the delay time before the Key-off Noise is heard.

- * This parameter is only available for the E.PIANO section.

7. Dynamics (SUB/MIDI)

VALUE: 0 (OFF) - 10

This parameter adjusts the keyboard response of the SUB and MIDI sections relative to the PIANO and E.PIANO sections.

When the value is 10 (default), the keyboard response is normal. As the value decreases the keyboard response gradually becomes less dynamic, and at 0 becomes completely flat (i.e. fixed touch response).

- * This parameter is only available for the SUB and MIDI sections.

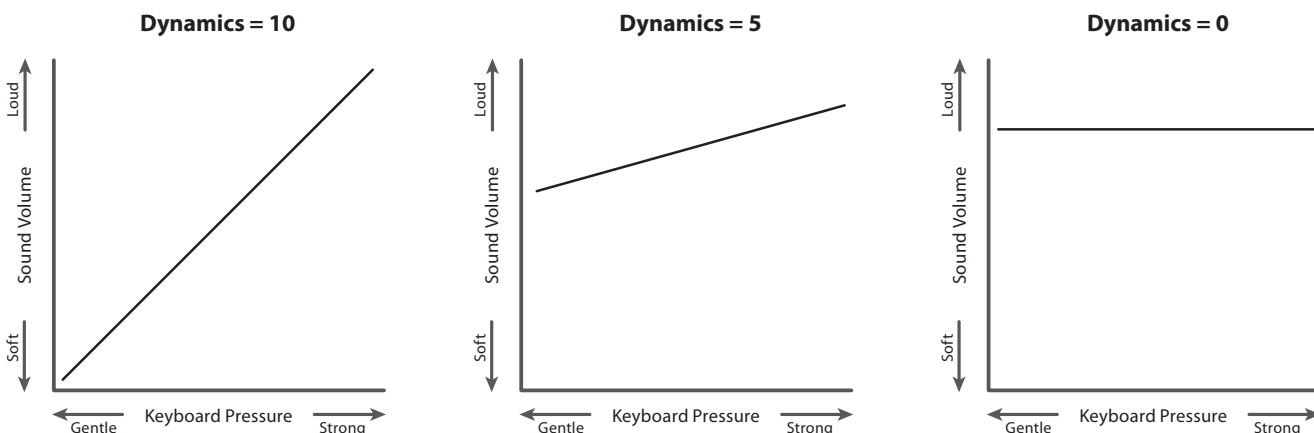

8. Solo (MIDI)

OFF/LAST/HI/LOW

This parameter turns the Solo mode ON/OFF and specifies the playing mode.

When set to ON, playing will be restricted to one note, even if more than one note is played simultaneously. This can be used to effectively simulate the performance characteristics of a monophonic synthesizer.

Solo Mode	Description
Last	Play last note of a group of notes.
High	Play highest note of a group of notes.
Low	Play lowest note of a group of notes.

- * This parameter is only available for the MIDI section.

9. Transmit (MIDI)

ON/OFF

This parameter determines whether or not the MP10 sends note data to external devices.

- * This parameter is only available for the MIDI section.

6 Controllers

1. Damper Pedal ON/OFF

This parameter determines whether or not the damper pedal is active for the selected section.

2. Damper Pedal Mode (NOT MIDI) 2 TYPES

This parameter selects the damper pedal mode for the internal sound sections. The 'Hold' setting allows the sound to be sustained indefinitely, without decay.

Section	Damper Pedal Mode
PIANO	Normal, Hold
E.PIANO	Normal, Hold
SUB	Normal, Hold

* This parameter is not available for the MIDI section.

5. Pitch Bend Wheel ON/OFF

This parameter determines whether or not the pitch bend wheel is active for the selected section.

7. Modulation Wheel ON/OFF

This parameter determines whether or not the modulation wheel is active for the selected section.

9. Expression Pedal ON/OFF

This parameter determines whether or not the expression pedal is active for the selected section.

* For more information about connecting pedals, please refer to page 14.

3. Left Pedal ON/OFF

This parameter determines whether or not the left pedal is active for the selected section.

4. Left Pedal Assign SOFT/SOSTENUTO

This parameter determines whether the left pedal of the F-20 twin pedal unit functions as a Soft or Sostenuto pedal. This is a common parameter for all three sound sections.

The MIDI section is controlled independently, and can be assigned a CC# 0-119 or an after touch command.

Value	Description
Soft	The left pedal functions as a soft pedal.
Sostenuto	The left pedal functions as a sostenuto pedal.

* When the Damper Pedal Mode parameter is set to Normal the sostenuto pedal functions with a natural decay. When set to Hold, the sostenuto pedal functions with a indefinite sustain.

* This parameter is common for all three sound sections. The MIDI section is separate, and controlled independently.

6. Pitch Bend Wheel Range VALUE: 0 - 7 OR 0 - 12

This parameter sets the range of the pitch bend wheel in semi-tone steps. The maximum range differs for the internal sound (0 - 7) and MIDI (0 - 12) sections.

PIANO/SUB: 11 FUNCTIONS
E.PIANO: 14 FUNCTIONS
MIDI: 0 - 119, AFT

8. Modulation Wheel Assign

This parameter determines the function of the modulation wheel. This is a common parameter for all three sound sections, where the default function is Modulation.

The MIDI section is controlled independently, and can be assigned a CC# 0-119 or an after touch command.

* Please refer to the end of this section for a list of assignable functions.

* This parameter is common for all three sound sections. The MIDI section is separate, and controlled independently.

PIANO/SUB: 11 FUNCTIONS
E.PIANO: 14 FUNCTIONS
MIDI: 0 - 119, AFT

10. Expression Pedal Assign

This parameter determines the function of the expression pedal. This is a common parameter for all three sound sections, where the default function is Expression.

The MIDI section is controlled independently, and can be assigned a CC# 0-119 or an after touch command.

* Please refer to the end of this section for a list of assignable functions.

* This parameter is common for all three sound sections. The MIDI section is separate, and controlled independently.

11. Foot Switch

ON/OFF

This parameter determines whether or not the foot switch pedal is active for the selected section.

* For more information about connecting pedals, please refer to page 14.

12. Foot Switch Assign

This parameter determines the function of the foot switch pedal. This is a common parameter for all three sound sections, where the default function is Sostenuto.

The MIDI section is controlled independently, and can be assigned a CC# 0-119 or an after touch command.

* Please refer to the end of this section for a list of assignable functions.

* This parameter is common for all three sound sections.
 The MIDI section is separate, and controlled independently.

■ Assignable functions for modulation wheel, expression pedal, & foot switch

PIANO/E.PIANO/SUB sections	PIANO/SUB sections only	E.PIANO section only
Modulation	EFX Dry/Wet	EFX1 Dry/Wet
Panpot	EFX Parameter 1	EFX1 Parameter 1
Expression	EFX Parameter 2	EFX1 Parameter 2
Damper		EFX2 Dry/Wet
Sostenuto		EFX2 Parameter 1
Soft		EFX2 Parameter 2
Resonance		
Cut off		

7 Knob Assign

The Knob Assign screen is used to assign EDIT menu parameters to the four main control knobs A, B, C, and D for direct, real-time adjustment in Play Mode. Two groups of knob parameters (primary and secondary) can be assigned to each PIANO, E.PIANO, SUB, and MIDI section, providing extensive control over the selected sounds.

■ Assigning parameters to each knob

Enter the Knob Assign screen for the desired section.

Turn the four control knobs (A, B, C, D) to specify which parameter should be assigned to each control knob in Play Mode.

* Press the CURSOR ▲ or CURSOR ▼ buttons to alternate between the primary and secondary control knob groups.

* For more information about adjusting parameters in Play Mode, please refer to page 19.

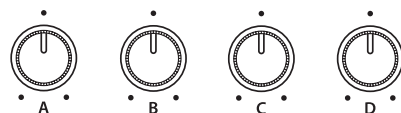

8 Sound Edit

1. Attack Time

VALUE: -64 --+63

This parameter adjusts the length of the attack. Higher values increase the attack time, resulting in a longer, slower attack for the selected sound.

3. Sustain Level

VALUE: -64 --+63

This parameter adjusts the volume level of the sustain heard while the key is held for the selected sound.

5. Filter Resonance

VALUE: -64 --+63

This parameter adjusts the amount of the harmonic overtone around the cut-off frequency for the selected sound.

7. Panpot

VALUE: L64 - R63

This parameter adjusts the left/right position of the selected sound within the stereo field.

2. Decay Time

VALUE: -64 --+63

This parameter adjusts the length of the decay from peak level to sustain level for the selected sound.

4. Release Time

VALUE: -64 --+63

This parameter adjusts the amount of time required for the sound to fade out after the keys are released for the selected sound.

6. Filter Cut-off

VALUE: -64 --+63

This parameter adjusts the frequency of the cut-off. Raising the cut-off level increases the brightness of the sound, while lowering the cut-off level results in a duller sound.

8. Volume

VALUE: 0 - 127

This parameter adjusts the volume level of the selected sound independently of the section's volume fader.

EDIT Menu parameters (MIDI)

1 Program

1. Program

VALUE: 1 - 128

This parameter determines which Program Change Number will be transmitted when a SETUP is recalled. Select the desired Program number for the sound you want to select on the external MIDI device.

2. Bank MSB/LSB

VALUE: 0 - 127, 0 - 127

This parameter determines which MSB and LSB number will be transmitted when a SETUP is recalled. The MIDI standard allocates 128 storage spaces, however this number can be expanded using an MSB and an LSB.

* Please refer to the owner's manual of the connected MIDI device for further information.

2 Transmit

Transmit parameters are SYSTEM parameters. These parameters are memorised automatically when exiting the EDIT menu and do not need to be stored to each SETUP.

1. Send Program

ON/OFF

This parameter determines whether or not a Program Change Number will be transmitted when a SETUP is recalled.

To change sounds on external MIDI devices when calling a SETUP, set this parameter to ON.

2. Send Bank

ON/OFF

This parameter determines whether or not Program Bank Numbers (MSB, LSB) will be transmitted when a SETUP is recalled.

If the external MIDI device requires a Bank Select message, set this parameter to ON.

3. Send Volume

ON/OFF

This parameter determines whether or not an initial MIDI Volume message will be transmitted when a SETUP is recalled.

* Moving the volume fader(s) will still transmit volume messages even if this parameter is set to OFF.

4. Send Knobs

ON/OFF

This parameter determines whether or not control knob settings will be transmitted (ON) or not (OFF) when a SETUP is recalled.

* Moving the control knobs will still transmit the values even if this parameter is set to OFF.

5. Transmit Recorder

ON/OFF

This parameter determines whether or not data will be transmitted when playing internal recorder songs.

3 Receive

Receive parameters are all SYSTEM parameters. These parameters are memorised automatically when exiting the EDIT menu and do not need to be stored to each SETUP.

1. Receive Mode

PANEL/SECTION/OMNI ON

This parameter determines how the MP10 receives MIDI data.

Value	Receive Mode
Panel	Received data controls the whole panel.
Section	Received data controls sections individually via each receive channel.
Omni On	Received data controls the whole panel, regardless of the MIDI channel.

2. Piano Channel

VALUE: 1CH - 16CH

This parameter determines the PIANO section's Receive Channel when the Receive Mode parameter is set to Section.

2. E.PIANO Channel

VALUE: 1CH - 16CH

This parameter determines the E.PIANO section's Receive Channel when the Receive Mode parameter is set to Section.

3. SUB Channel

VALUE: 1CH - 16CH

This parameter determines the SUB section's Receive Channel when the Receive Mode parameter is set to Section.

4 MMC

MMC parameters are all SYSTEM parameters. These parameters are memorised automatically when exiting the EDIT menu and do not need to be stored to each SETUP.

1. MMC Dev. ID

VALUE: 0 - 127

This parameter determines the device ID of the MMC (MIDI Machine Control).

2. MMC Commands

16 COMMANDS

This parameter assigns MMC or realtime commands (see table below) to the 6 RECORDER CONTROL buttons.

■ Assignable RECORDER CONTROL button commands

MMC Commands	
01: STOP	08: RECORD PAUSE
02: PLAY	09: PAUSE
03: DEFERRED PLAY	0A: EJECT
04: FAST FORWARD	0B: CHASE
05: REWIND	0C: COMMAND ERROR RESET
06: RECORD STROBE	0D: MMC RESET
07: RECORD EXIT	

Realtime Commands
FA: RealtimeSTART
FB: RealtimeCONTINUE
FC: RealtimeSTOP

Overview of the STORE Button

After using the EDIT menu and control knobs to adjust the parameters for the selected sound, the STORE button is used to memorise the settings, and ensure the changes are not lost when turning the instrument OFF or selecting other sounds.

The STORE button has three different functions: to store individual sounds, to store the entire panel configuration (SETUP), and to store the current panel configuration as the default (POWERON).

■ STORE button functions

STORE function	Description
SOUND	Store the selected sound's EDIT menu parameters* to the variation button.
SETUP	Store all EDIT menu parameters, all sound section panel settings, and EQ section settings to a SETUP memory.
POWERON	Store all EDIT menu parameters, all sound section panel settings, and EQ section settings as the default.

* except Common parameters (page 34).

1 Storing a SOUND

This function will store the selected sound's EDIT menu parameters to the variation button, thus overwriting the existing sound.

■ Entering the STORE screen

Press the STORE button.

The LED indicator for the STORE button will turn ON, and the store selection screen will be shown in the LCD display.



■ Selecting the Store Sound function

Press the F1 function button (SOUND) to select the Store Sound function.

Then press the F4 function button (EXEC).

The Store Sound confirmation screen will be shown in the LCD display.

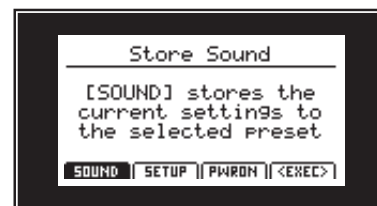

■ Confirming the Store Sound function

Press the +/YES button to confirm the Store Sound function, or the -/NO button to return to the store selection screen.

* The existing sound will be overwritten with the adjusted sound.

* To prevent data loss, avoid turning the power OFF while the MP10 is storing SETUP settings.

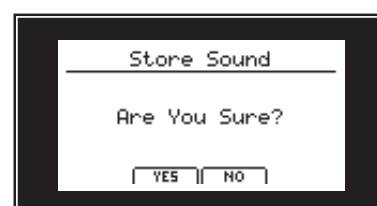

2 Storing a SETUP

This function will store all the EDIT menu parameters for the PIANO, E.PIANO, SUB, and MIDI section, panel button and knob states, and EQ settings to one of the MP10's 156 SETUP memories.

■ Entering the STORE screen

Press the STORE button.

The LED indicator for the STORE button will turn ON, and the store selection screen will be shown in the LCD display.



■ Selecting the Store Setup function

Press the F2 function button (SETUP) to select the Store Setup function.

Then press the F4 function button (EXEC).

The SETUP bank/memory selection and name input screen will be shown in the LCD display.



■ Naming the SETUP, selecting the bank/memory

Turn control knobs A and B to move the cursor position and select the characters for the SETUP name.

Press the BANK ◀ or BANK ▶ buttons and SETUP memory buttons (1-6) to select the bank and memory for the new SETUP.

Then press the F4 function button (EXEC).

The Store Setup confirmation screen will be shown in the LCD display.

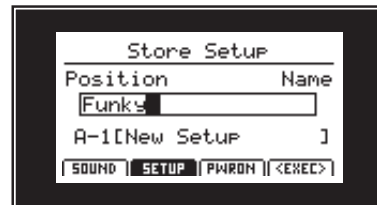

■ Confirming the Store Setup function

Press the +/YES button to confirm the Store Setup function, or the -/NO button to return to the previous screen.

- * The existing SETUP memory will be overwritten with the new SETUP.
- * To prevent data loss, avoid turning the power OFF while the MP10 is storing SETUP settings.
- * When the SETUP has been stored and the SETUP button has been turned OFF, the panel settings will return to the POWERON state.



3 Storing POWERON settings

This function will store all the EDIT menu parameters for the PIANO, E.PIANO, SUB, and MIDI section, panel button and knob states, and EQ settings to the MP10's default POWERON memory.

■ Entering the STORE screen

Press the STORE button.

The LED indicator for the STORE button will turn ON, and the store selection screen will be shown in the LCD display.



■ Selecting the Store PowerOn function

Press the F3 function button (PWRON) to select the Store PowerOn function.

Then press the F4 function button (EXEC).

The Store PowerOn confirmation screen will be shown in the LCD display.

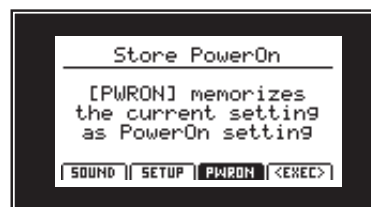

■ Confirming the Store PowerOn function

Press the +/YES button to confirm the Store PowerOn function, or the -/NO button to return to the previous screen.

* The existing POWERON memory will be overwritten.

* To prevent data loss, avoid turning the power OFF while the MP10 is storing SETUP settings.

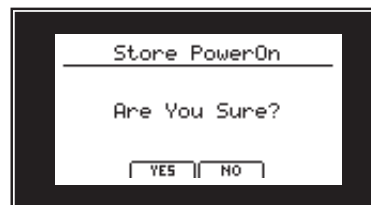

SETUP memories

The MP10 allows up to 156 SETUPS (26 x 6) to be stored in memory. This page explains how to select the bank and memory, and recall the SETUP.

■ Turning the SETUP ON/OFF

Press the SETUP section's ON/OFF button to turn SETUPS ON.

The LED indicator for the SETUP section's ON/OFF button will turn ON and the A-1 SETUP will be recalled automatically.

SETUPS OFF



ON/OFF



SETUPS ON

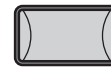

ON/OFF

■ Selecting SETUPS

Press the BANK ◀ or BANK ▶ buttons to cycle through the available SETUP banks.

* There are 26 SETUP banks, ranging from A - Z.

The SETUP list for the selected bank will be shown in the LCD display.

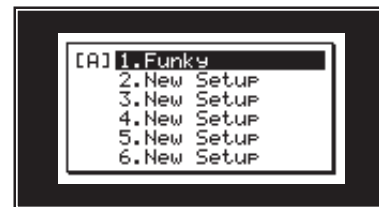

While the SETUP list is shown:

Press the SETUP memory buttons (1-6) to select the desired SETUP memory.

* There are 6 SETUP memories per bank.

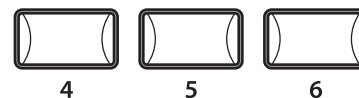
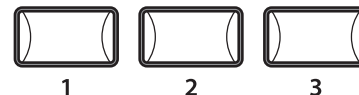

Overview of the Recorder

The MP10's Recorder features a variety of useful functions to record and playback performances from the instrument's internal memory or a USB memory device. The characteristics of each method are outlined below.

■ MP10 Recorder characteristics

	Song Recorder (Internal Memory)	Audio Recorder (USB Memory)
Stored/saved format	SMF (MIDI)	MP3/WAV (audio)
Maximum song length	90,000 notes	Depends on device capacity
Maximum no. of songs	10 songs	Depends on device capacity
Example applications	Sketching ideas, recording finished performances, remixing and further editing on a computer.	Emailing to friends, burning to audio CD, etc.
Playback methods	Playback songs on MP10 and other MIDI devices	Playback songs on MP10 and audio players etc.
Adjustable tempo	Yes, during playback	No
Overdubbing	No	Yes, unlimited overdubs
Conversion options	Can be converted to MP3/WAV	Cannot be converted to SMF (MIDI)

■ Entering the Recorder

Press the RECORDER button.

The LED indicator for the RECORDER button will turn ON to indicate that the Recorder function is selected.



■ Selecting the Recorder mode

Press the F1 function button to alternate between the Internal Song Recorder and the USB Audio Recorder functions.

* If a USB memory device is connected when entering the recorder, the USB Audio Recorder function will be selected automatically.

* If a USB memory device is not connected when entering the recorder, the Internal Song Recorder function will be selected automatically.



■ Exiting the Recorder

Press the RECORDER button.

The LED indicator for the RECORDER button will turn OFF and the display will return to the Play Mode screen.



■ USB Functions

Additional USB functions to delete and rename files stored on USB memory devices can be found in the USB Menu (page 66).

Song Recorder (Internal Memory)

The Song Recorder function allows up to 10 different songs to be recorded, stored in internal memory, and played back at the touch of a button. Once recorded, songs can be saved to USB memory in Standard MIDI File (SMF) format, or converted to MP3/WAV audio files.

1 Recording a song

1. Entering song recorder mode

Press the RECORDER button.

The LED indicator for the RECORDER button will turn ON and the MIDI recorder screen will be shown in the LCD display.



If a USB memory device is connected, press the F1 button (MIDI) to select the MIDI recorder function.

Turn control knob C to select the song memory to be used for the new recording.

* There are 10 internal song recorder memories.

* If the selected song memory already contains recording data, it will be erased automatically when the new song is recorded.



2. Starting the song recorder

Press the ● button.

The LED indicator for the ● button will start to flash, to indicate that the recorder is in standby mode.

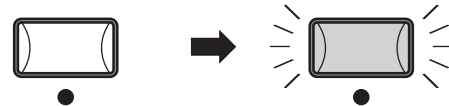

Press a key on the keyboard.

The LED indicator for the ● button will turn ON, a counting timer will be shown in the centre of the LCD, and recording will start.

* Recording can also be started by pressing the ►/■ button, allowing a rest period or empty bar to be inserted at the beginning of the song.

* The metronome can be enabled before recording to assist with timing etc. When enabled, a one bar count-in will be added before recording begins.



3. Stopping the song recorder

Press the ►/■ button.

The LED indicator for the ● button will turn OFF, and recording will stop.



After a brief pause, the MIDI player screen will be shown in the LCD display.

* To prevent data loss, avoid turning the power OFF while the MP10 is saving internal recorder songs.

* The maximum recording capacity is approximately 90,000 notes, with button and pedal presses also counted as one note.

* If the maximum recording capacity is reached during recording, the recorder will stop automatically.

* Recorder songs will remain in memory after the power is turned OFF.

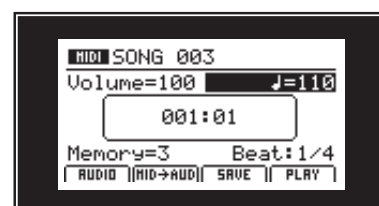

2 Playing back a song

This function is used to playback recorder songs stored in internal memory. To playback a song immediately after recording, start this process from step 2.

1. Entering song playback mode

Press the RECORDER button.

The LED indicator for the RECORDER button will turn ON and the MIDI recorder screen will be shown in the LCD display.



If a USB memory device is connected, press the F1 function button (MIDI) to select the MIDI recorder function.

Turn control knob C to select the song memory to playback.

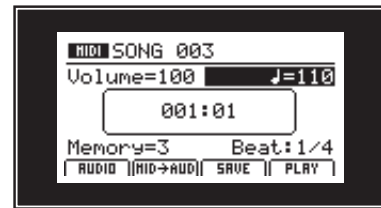

2. Starting song playback

Press the F4 function button (PLAY) or ►/■ button.

The LED indicator for the ►/■ button will turn ON, and the selected song will start to play.



Press ◀◀ or ▶▶ buttons to fast-forward or rewind the song. The A and B control knobs can also be used to adjust the volume and tempo of the song playback.

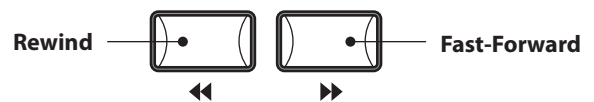

Press the ►/■ button to stop playback, then press the ◀ button to reset the playing position of the song to the beginning.

* To activate the 'Chain Play' mode, press and hold the ►/■ button. All recorded songs will be played in sequence.

■ A-B Repeat function

The A-B Repeat function allows one section of a song to be repeated continuously. During song playback:

Press the A↔B button once to set the start point.

The LED indicator for the A↔B button will start to flash.

Press the A↔B button again to set the end point.

The LED indicator for the A↔B button will turn ON and the specified section will repeat continuously.

To cancel the A-B repeat function, press the A↔B button once again.

The LED indicator for the A↔B button will turn OFF and normal playing will resume.

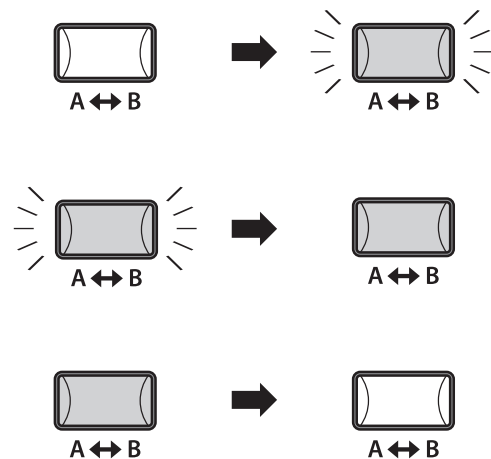

3 Saving a song as an SMF file

This function is used to save recorder songs to a USB memory device in SMF format (Standard MIDI Format).

1. Selecting the Save SMF function

After selecting the MIDI recorder and recording a song:

Connect a USB memory device.

* USB devices should be formatted to use the 'FAT' or 'FAT32' filesystems.

The USB device will be scanned, and the MID→AUD and SAVE function will appear at the bottom of the LCD display.

Press the F3 function button (SAVE).

The Save SMF screen will be shown in the LCD display.

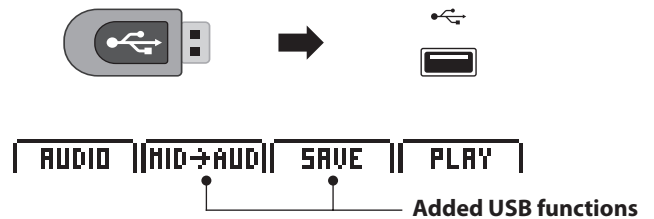

2. Entering a filename

Turn control knobs A and B to move the position of the cursor and change the character.

* Saved SMF files are limited to a maximum name length of 18 characters.

* The saved SMF file will be stored in the root folder of the USB memory device. It is not possible to store the file in a different folder.

Turn control knob C to select the song memory to be saved to USB memory in SMF format.



3. Saving the song

Press the F4 function button (EXEC).

The save confirmation screen will be shown in the LCD display.

Press the F2 function button (YES) or F3 function button (NO) to confirm or cancel the save operation.

After saving the SMF file, the MIDI recorder screen will be shown in the LCD display.

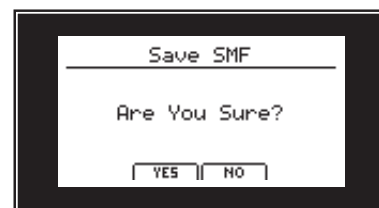

4 Converting a song to an audio file

This function is used to convert recorder songs stored in memory to MP3/WAV audio files stored on a USB device.

Please refer to the explanation in the Audio Recorder section of this chapter (page 64).

5 Loading an SMF file into memory

This function can be used to load SMF files into an empty recorder song memory.

■ Preparing the USB memory device

First, prepare a selection of SMF MIDI files, copying the data to a USB memory device.

* USB devices should be formatted to use the 'FAT' or 'FAT32' filesystems.

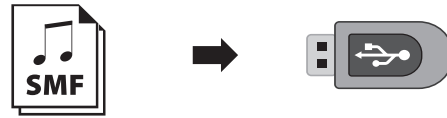

1. Selecting the Load SMF function

After selecting the MIDI recorder:

Turn control knob C to select an empty song memory, or follow the instructions on page 57 to erase an existing song memory.

Connect a USB memory device.

* USB devices should be formatted to use the 'FAT' or 'FAT32' filesystems.

The USB device will be scanned, and the LOAD function will appear at the bottom of the LCD display.

Press the F3 function button (LOAD).

A listing of the SMF files stored in the root folder of the USB device will be shown in the LCD display.

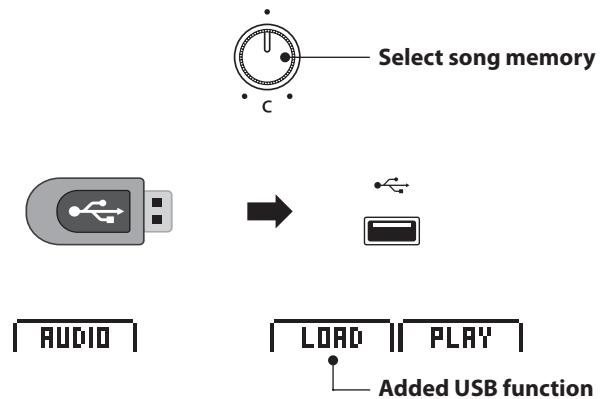

■ USB device file/folder listing screen

The MP10's file/folder listing screen lists the files and folders stored in the root of the USB device.

The selection cursor can be moved by turning control knob A, or pressing the CURSOR ▲ or CURSOR ▼ buttons.

The < > symbols are used to indicate a folder, while the topmost [dir up] entry is used to return to the parent/previous folder.



2. Selecting the SMF file to load

Turn control knob A, or press the CURSOR ▲ or CURSOR ▼ buttons to select the desired MIDI file.

Press the F4 function button (NEXT).

The Load SMF screen will be shown in the LCD display.



5 Loading an SMF file into memory (cont.)

3. Selecting the keyboard and drum channels

Turn control knobs C and D to specify which channels of the SMF file should be loaded into the MP10 recorder's keyboard and drum tracks.

Press the F3 function button (LISTEN) to audition the current channel settings.

Press the F4 function button (EXEC) to load the selected SMF file into the song memory.

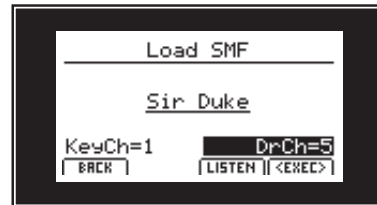

4. Starting song playback

Press the F4 function button (PLAY) or ►/■ button.

The LED indicator for the ►/■ button will turn ON, and the selected audio file will start to play.

Press ◀◀ or ▶▶ buttons to fast-forward or rewind the song. The A and B control knobs can also be used to adjust the volume and tempo of the song playback.

Press the ►/■ button to stop playback, then press the ◀ button to reset the playing position of the song to the beginning.

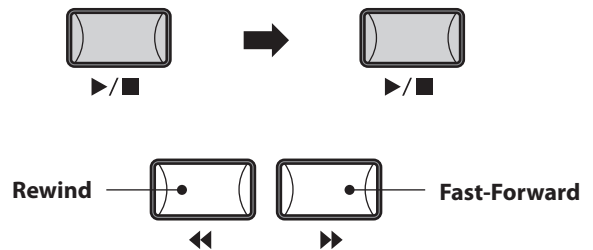

■ A-B Repeat function

The A-B Repeat function allows one section of a song to be repeated continuously. During song playback:

Press the A↔B button once to set the start point.

The LED indicator for the A↔B button will start to flash.

Press the A↔B button again to set the end point.

The LED indicator for the A↔B button will turn ON and the specified section will repeat continuously.

To cancel the A-B repeat function, press the A↔B button once again.

The LED indicator for the A↔B button will turn OFF and normal playing will resume.

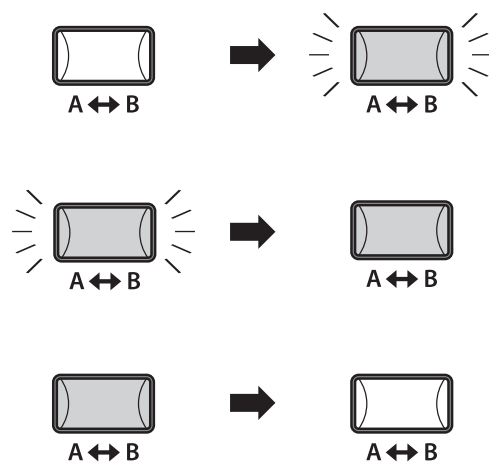

6 Erasing a song

This function is used to erase songs that have been recorded incorrectly, or are simply no longer required.

1. Selecting the song to erase

After selecting the MIDI recorder and recording a song:

Turn control knob B to select the song memory to be erased.

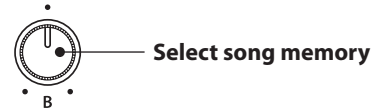

2. Erasing the selected song

Press the ● and ►/■ buttons simultaneously.

A message will be shown in the LCD display to indicate that the selected song memory has been erased.

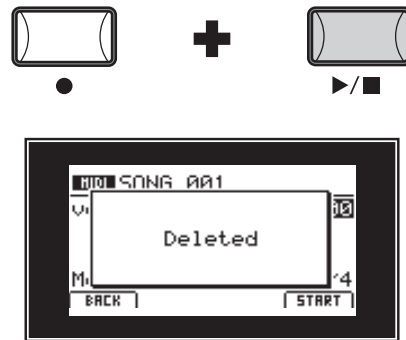

■ Erasing all recorder songs

To erase all recorder songs, use the Reset Recorder function in the Reset category of the SYSTEM menu (page 75).

Audio Record/Playback (USB Memory)

The MP10 is also capable of recording performances (including LINE IN input audio) as digital audio - saving the data to a USB memory device in either MP3 or WAV format. This useful function allows professional quality recordings to be produced directly on the instrument - without the need for additional sound equipment - then emailed to band members, listened to away from the instrument, or edited and remixed further using an audio workstation.

Audio Recorder format specifications

Audio Format	Specifications	Bitrate
MP3	44.1 kHz, 16 bit, Stereo	192 kbit/s (fixed)
WAV	44.1 kHz, 16 bit, Stereo	1,411 kbit/s (uncompressed)

MPEG Layer-3 audio coding technology licensed from Fraunhofer IIS and Thomson.

MP3 codec is Copyright (c) 1995-2007, SPIRIT

1 Recording an audio file

1. Entering audio recorder mode

Connect a USB memory device.

* USB devices should be formatted to use the 'FAT' or 'FAT32' filesystems.



Press the RECORDER button.

The LED indicator for the RECORDER button will turn ON and the Audio recorder screen will be shown in the LCD display.



2. Selecting the audio recorder file format

Turn control knob B to select the desired audio recorder file format.

* MP3 audio files require less storage space than WAV audio files.

* A 1 GB USB memory device can store over 12 hours of MP3 audio data.

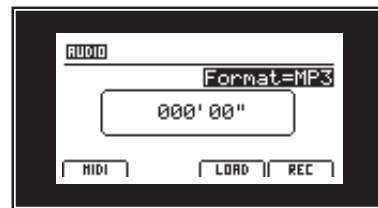

3. Starting the audio recorder

Press the F4 function button (REC) or ● button.

The LED indicator for the ● button will start to flash, to indicate that the recorder is in standby mode.

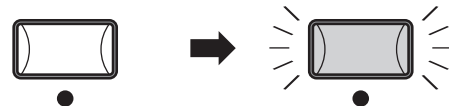

Press a key on the keyboard.

The LED indicator for the ● button will turn ON, a counting timer will be shown in the centre of the LCD, and recording will start.

* Recording can also be started by pressing the ►/■ button, allowing a rest period or empty bar to be inserted at the beginning of the recording.

* The LINE IN input audio will also be recorded to the MP3/WAV file.

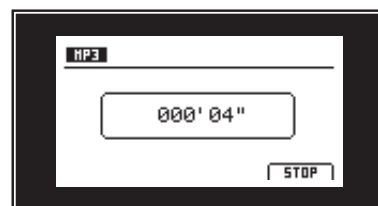

4. Stopping the audio recorder, auditioning the recording

Press the ►/■ button.

The LED indicator for the ● button will turn OFF, and recording will stop.

After a brief pause, the Audio player screen will be shown in the LCD display.

Press the F4 function button (PLAY) to audition the recording before saving.

* For more information about the player controls, please refer to page 60.

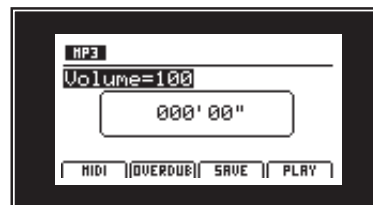
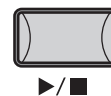

5. Saving the recorded audio file

While the Audio player screen is shown in the LCD display:

Press the F3 function button (SAVE).

The Save Audio screen will be shown in the LCD display.

Turn control knobs A and B to move the position of the cursor and change the character.

* Saved audio files are limited to a maximum name length of 18 characters.

* The saved audio file will be stored in the root folder of the USB memory device. It is not possible to store the file in a different folder.

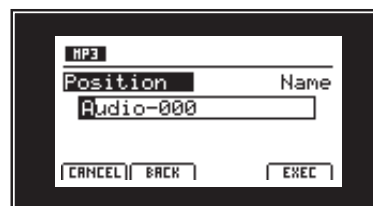

6. Confirming the save

Press the F4 function button (EXEC).

The save confirmation screen will be shown in the LCD display.

Press the F2 function button (YES) or F3 function button (NO) to confirm or cancel the save audio operation.

After saving the audio file, the Audio record/play screen will be shown in the LCD display.

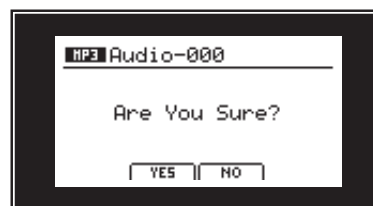

■ Using the Metronome with the Audio Recorder

The metronome can be enabled to allow rhythm patterns to be recorded while playing. When enabled, a one bar count-in will be added before recording begins.

To record using the metronome to assist with timing, yet without being added to the audio file, first use the Song Recorder (with the metronome enabled), then the Convert to Audio function to create the audio file.



METRONOME

Audio Record/Playback (USB Memory)

The MP10 is also capable of playing MP3 and WAV audio files stored on a USB memory device. This function allows performing musicians to play along with professional backing tracks, or conveniently learn the chords or melody for a new piece.

■ Audio Player supported format specifications

Audio Format	Specifications	Bitrate
MP3	32 kHz/44.1 kHz/48 kHz, Mono/Stereo	8-320 kbit/s (fixed & variable)
WAV	32 kHz/44.1 kHz/48 kHz, Mono/Stereo, 8 bit/16 bit	-

MPEG Layer-3 audio coding technology licensed from Fraunhofer IIS and Thomson.
MP3 codec is Copyright (c) 1995-2007, SPIRIT

■ Preparing the USB memory device

First, prepare a selection of MP3 or WAV audio files, copying the data to a USB memory device.

* USB devices should be formatted to use the 'FAT' or 'FAT32' filesystems.

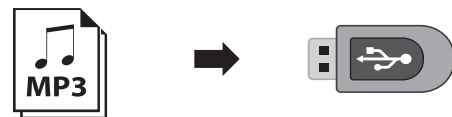

2 Playing an audio file

1. Entering audio playback mode

Connect a USB memory device.

Press the RECORDER button.

The LED indicator for the RECORDER button will turn ON and the Audio recorder screen will be shown in the LCD display.

Press the F3 function button (LOAD).

A listing of the MP3 files stored in the root folder of the USB device will be shown in the LCD display.

* To list the WAV files stored on the USB device, press the F3 function button.

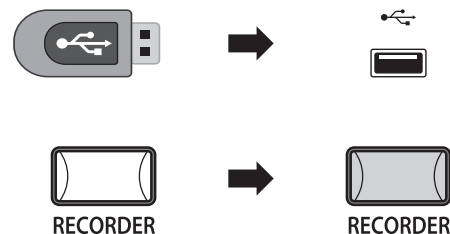

■ USB device file/folder listing screen

The MP10's file/folder listing screen lists the files and folders stored in the root of the USB device.

The selection cursor can be moved by turning control knob A, or pressing the CURSOR ▲ or CURSOR ▼ buttons.

The < > symbols are used to indicate a folder, while the topmost [dir up] entry is used to return to the parent/previous folder.

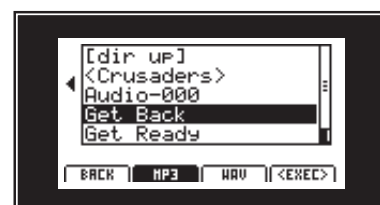

2. Selecting the audio file to load

Turn control knob A, or press the CURSOR ▲ or CURSOR ▼ buttons to select the desired MP3 file.

Press the F4 function button (EXEC).

The Audio Player screen will be shown in the LCD display.

* If available, the audio file's metadata (ID3 tags etc.) will also be shown.

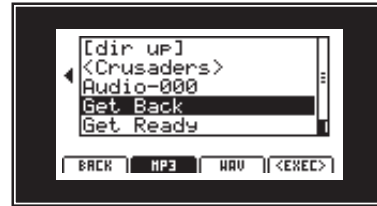

3. Starting song playback

Press the F4 function button (PLAY) or ►/■ button.

The LED indicator for the ►/■ button will turn ON, and the selected audio file will start to play.

Press ◀◀ or ▶▶ buttons to fast-forward or rewind the audio file, and control knob A to adjust the playback volume.

Press the ►/■ button to stop playback, then press the ◀ button to reset the playing position of the audio file to the beginning.

* To activate the 'Chain Play' mode, press and hold the ►/■ button when selecting the file. The contents of the current folder will be played in alphabetical order after the initial file has finished playing.

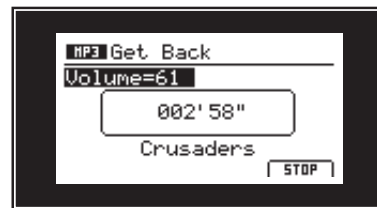

■ A-B Repeat function

The A-B Repeat function allows one section of a song to be repeated continuously. During song playback:

Press the A↔B button once to set the start point.

The LED indicator for the A↔B button will start to flash.

Press the A↔B button again to set the end point.

The LED indicator for the A↔B button will turn ON and the specified section will repeat continuously.

To cancel the A-B repeat function, press the A↔B button once again.

The LED indicator for the A↔B button will turn OFF and normal playing will resume.

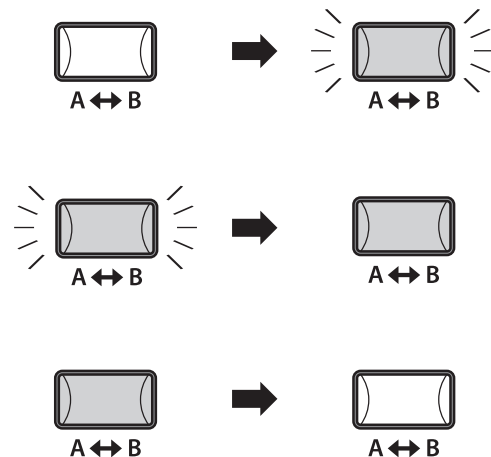

3 Overdubbing an audio file

The overdub function adds supplementary recording(s) to an existing audio file, facilitating simple multi-track recordings to be produced directly on the instrument.

Each overdub is recorded to a temporary file (i.e. the original audio file is not modified), allowing an unlimited number of overdubs that to be made before eventually saving the final recording.

1. Entering audio playback mode

Connect a USB memory device.



Press the RECORDER button.

The LED indicator for the RECORDER button will turn ON and the Audio recorder screen will be shown in the LCD display.



Press the F3 function button (LOAD).

A listing of the MP3 files stored in the root folder of the USB device will be shown in the LCD display.

* To list the WAV files stored on the USB device, press the F3 function button.

2. Selecting the audio file to overdub

Turn control knob A, or press the CURSOR ▲ or CURSOR ▼ buttons to select the desired MP3 file.

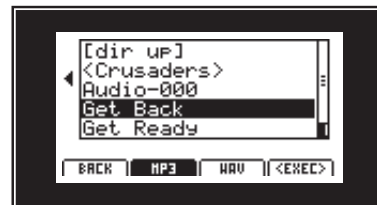

Press the F4 function button (EXEC).

The Audio Player screen will be shown in the LCD display.

* If available, the audio file's metadata (ID3 tags etc.) will also be shown.

3. Selecting the overdub function and file format

Press the F2 function button (OVERDUB).

The overdub file format selection screen will be shown in the LCD display.

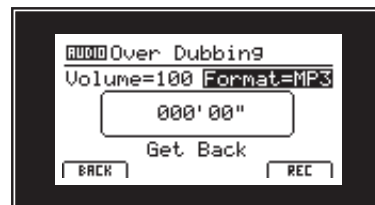

Turn control knob B to select the desired overdub file format.

* MP3 audio files require less storage space than WAV audio files.

* A 1 GB USB memory device can store over 12 hours of MP3 audio data.

4. Starting the overdub

Press the F4 function button (REC) or ● button.

The LED indicator for the ● button will start to flash, to indicate that overdubbing is in standby mode.

If necessary, turn control knob A to adjust the volume of the source audio file.

Press a key on the keyboard.

The LED indicator for the ● button will turn ON, a counting timer will be shown in the centre of the LCD, and dubbing will start.

* Overdubbing can also be started by pressing the ►/■ button, allowing a rest period or empty bar to be inserted at the beginning of the dub.

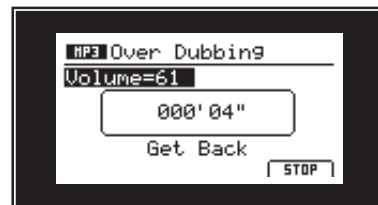
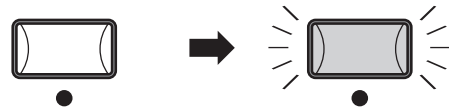

5. Stopping the dubbing, auditioning the recording

Press the F4 function button (STOP) ►/■ button.

The LED indicator for the ● button will turn OFF, and dubbing will stop.

After a brief pause, the Audio player screen will be shown in the LCD display.

Press the F4 function button (PLAY) to audition the overdub before saving, or the F2 function button (OVERDUB) to dub an additional layer of audio to the overdubbed file.

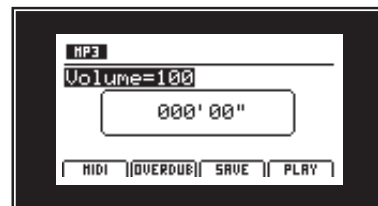

6. Saving the dubbed audio file

While the Audio player screen is shown in the LCD display:

Press the F3 function button (SAVE).

The Save Audio screen will be shown in the LCD display.

Turn control knobs A and B to move the position of the cursor and change the character.

* Saved audio files are limited to a maximum name length of 18 characters.

* The saved audio file will be stored in the root folder of the USB memory device. It is not possible to store the file in a different folder.

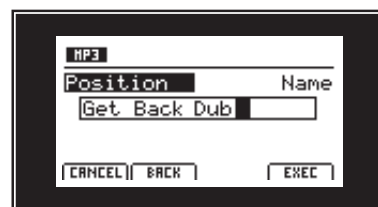

7. Confirming the save

Press the F4 function button (EXEC).

The save confirmation screen will be shown in the LCD display.

Press the F2 function button (YES) or F3 function button (NO) to confirm or cancel the save audio operation.

After saving the audio file, the Audio record/play screen will be shown in the LCD display.

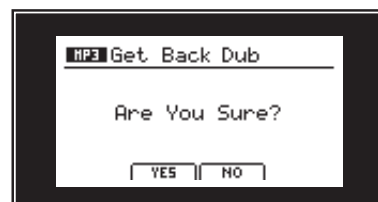

4 Converting a recorder song to an audio file

This function allows recorder songs stored in internal memory to be played back and saved (converted) as an audio file to a USB device in either MP3 or WAV format.

1. Selecting the MIDI to Audio function

After selecting the MIDI recorder and recording a song:

Connect a USB memory device.

* USB devices should be formatted to use the 'FAT' or 'FAT32' filesystems.

The USB device will be scanned, and the MID→AUD and SAVE function will appear at the bottom of the LCD display.

Press the F2 function button (MID→AUD).

The MIDI to Audio screen will be shown in the LCD display.

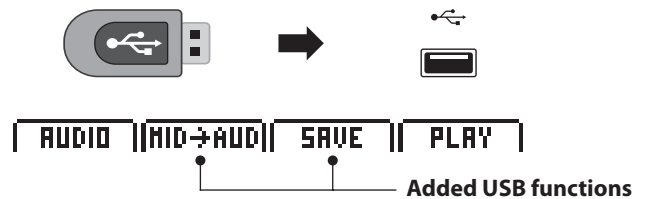

2. Selecting the audio format, starting the conversion

Turn control knob B to select the desired audio format for the converted recorder song.

Press the F4 function button (REC) or ● button.

The LED indicator for the ● button will start to flash, to indicate that the conversion is in standby mode.

Press the ►/■ button.

The LED indicator for the ● button will turn ON, a counting timer will be shown in the centre of the LCD, and the recorder song will be converted to an audio file.

* Notes played on the keyboard will also be recorded to the audio file.

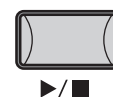

3. Stopping the conversion, auditioning the recording

Press the ►/■ button.

The LED indicator for the ● button will turn OFF, and the conversion will stop.

After a brief pause, the Audio player screen will be shown in the LCD display.

Press the F4 function button (PLAY) to audition the conversion before saving the audio file.

* For more information about the player controls, please refer to page 60.

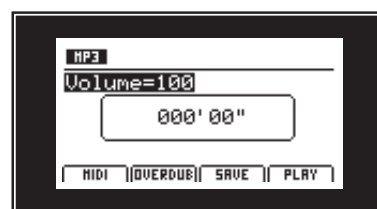
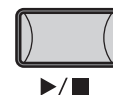

5. Saving the converted audio file

While the Audio player screen is shown in the LCD display:

Press the F3 function button (SAVE).

The Save Audio screen will be shown in the LCD display.

Turn control knobs A and B to move the position of the cursor and change the character.

* Saved audio files are limited to a maximum name length of 18 characters.

* The saved audio file will be stored in the root folder of the USB memory device. It is not possible to store the file in a different folder.



6. Confirming the save

Press the F4 function button (EXEC).

The save confirmation screen will be shown in the LCD display.

Press the F2 function button (YES) or F3 function button (NO) to confirm or cancel the save audio operation.

After saving the audio file, the Audio record/play screen will be shown in the LCD display.

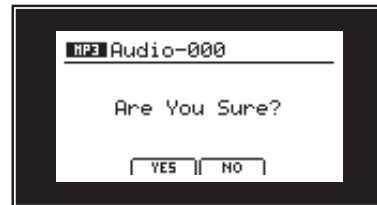

Overview of the USB Menu

The USB Menu contains functions to load, save, delete, and rename the various types of MP10 data stored on a USB memory device. It is also possible to format the memory device, erasing all stored data.

MP10 data types

Data type	Description	Extension
SOUND	A backup of a single SOUND's parameters.	.km5
SETUP	A backup of a single SETUP memory.	.km6
SMF	A standard MIDI format (SMF) song file.	.mid
Song	A MP3/WAV audio file or SMF song file.	.mp3, .wav, .mid
All Sound	A backup of all the MP10's stored SOUND parameters.	.km2
All Setup	A backup of all the MP10's SETUP memories.	.km3
All Backup	A backup of all the MP10's SETUP memories, SOUND parameters, and SYSTEM settings.	.km4

Entering the USB Menu

Connect a USB memory device.

* USB devices should be formatted to use the 'FAT' or 'FAT32' filesystems.



Press the USB button.

The LED indicator for the USB button will turn ON, and the USB Menu will be shown in the LCD display.



Selecting USB functions

Press the CURSOR buttons then the +/YES button or F4 function button (NEXT) to select and enter the desired category page.

Use the same control method once again to select each function.

Press the -/NO or F1 function button (BACK) to return to the previous screen.

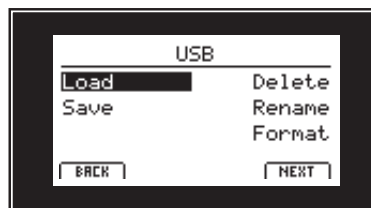

USB device file/folder listing screen

The MP10's file/folder listing screen lists the files and folders stored in the root of the USB device.

The selection cursor can be moved by turning control knob A, or pressing the CURSOR ▲ or CURSOR ▼ buttons.

The < > symbols are used to indicate a folder, while the topmost [dir up] entry is used to return to the parent/previous folder.

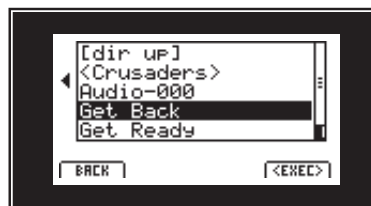

Load functions will overwrite the existing data stored in internal memory. Exercise caution when using these functions to avoid accidental data loss.

USB Menu functions

1 Load

These functions allow data stored on a USB memory device to be loaded into the instrument's internal memory.

1. Load One Sound

This function loads a SOUND file stored on a USB memory, replacing the preset parameters for that specific sound.

After selecting this function, select the desired SOUND file from the file/folder listing screen.

Finally, press the F2 or F3 function buttons to confirm or cancel the load operation.

* After loading, the SOUND will be selected automatically, and all other sections will be turned OFF. SETUPs will also be turned OFF.

3. Load SMF

This function loads an SMF song file stored on a USB memory device into the MP10's internal song recorder memory.

After selecting this function, select the desired SMF file from the file/folder listing screen. Then use the control knobs A, C, and D to specify the destination song memory and keyboard/drum channels.

Finally, press the F2 or F3 function buttons to confirm or cancel the load operation.

* After loading, the MIDI record/playback screen will be shown in the LCD display and the destination song memory will be selected automatically.

* For more information about the song recorder, please refer to page 52.

4. Load All Sound

This function replaces the preset parameters for all internal sounds from an All Sound file stored on a USB memory device.

After selecting this function, select the desired All Sound file from the file/folder listing screen.

Finally, press the F2 or F3 function buttons to confirm or cancel the load operation.

6. Load All Backup

This function restores the parameters for all SETUP memories, SOUND parameters, and SYSTEM settings from an All Backup file stored on a USB memory device.

After selecting this function, select the desired All Backup file from the file/folder listing screen.

Finally, press the F2 or F3 function buttons to confirm or cancel the load operation.

2. Load One Setup

This function loads a SETUP file stored on a USB memory device into one of the MP10's 156 SETUP memories.

After selecting this function, select the desired SETUP file from the file/folder listing screen. Then press the BANK and SETUP memory buttons to specify the destination SETUP memory.

Finally, press the F2 or F3 function buttons to confirm or cancel the load operation.

* After loading, the SETUP will be selected automatically.

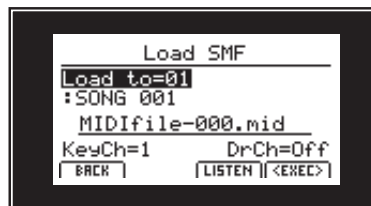

5. Load All Setup

This function restores all SETUP memories from an All Setup file stored on a USB memory device.

After selecting this function, select the desired All Setup file from the file/folder listing screen.

Finally, press the F2 or F3 function buttons to confirm or cancel the load operation.

2 Save

These functions allow data stored in the instrument's internal memory to be saved to a USB memory device.

1. Save One Sound

This function saves the currently selected sound's parameters to a USB memory device.

* If the MIDI section is currently selected, the current PIANO section sound will be saved automatically.

After selecting this function, a confirmation screen will be shown in the LCD display. Press the F4 function button (NEXT) to continue.

Enter a name for the saved SOUND file using control knobs A and B, then press the F4 function button (EXEC).

Finally, press the F2 or F3 function buttons to confirm or cancel the save operation.

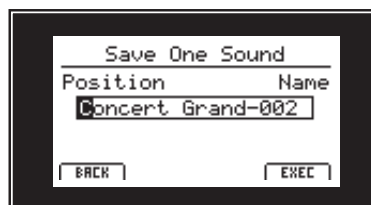
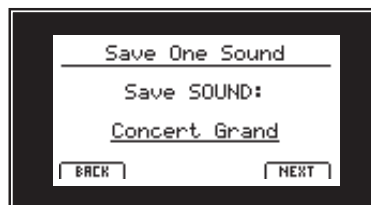

2. Save One Setup

This function saves a SETUP memory to a USB memory device.

After selecting this function, a confirmation screen will be shown in the LCD display. Press the BANK and SETUP memory buttons to specify the destination SETUP memory, then press the F4 function button (NEXT) to continue.

Enter a name for the saved SETUP file using control knobs A and B, then press the F4 function button (EXEC).

Finally, press the F2 or F3 function buttons to confirm or cancel the save operation.

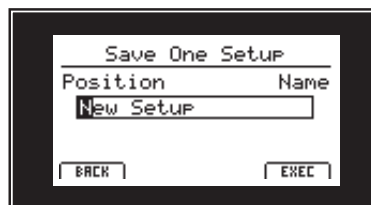

3. Save SMF

This function saves an internal recorder song to a USB memory device in SMF format.

After selecting this function, the Save SMF screen will be shown in the LCD display. Select the song memory to be saved using control knob C, and enter a name for the saved SMF file using control knobs A and B, then press the F4 function button (EXEC).

Finally, press the F2 or F3 function buttons to confirm or cancel the save operation.

* For more information about the song recorder, please refer to page 52.



4. Save All Sound

This function saves the parameters for all internal sounds to a USB memory device.

After selecting this function, enter a name for the saved AllSound file using control knobs A and B, then press the F4 function button (EXEC).

6. Save All Backup

This function saves the parameters for all internal sounds, all SETUP memories, and all SYSTEM settings to a USB memory device.

After selecting this function, enter a name for the saved AllBackup file using control knobs A and B, then press the F4 function button (EXEC).

5. Save All Setup

This function saves all of the SETUP memories stored in the instrument to a USB memory device.

After selecting this function, enter a name for the saved AllSetup file using control knobs A and B, then press the F4 function button (EXEC).

3 Delete

These functions allow data stored on a USB memory device to be deleted.



Delete functions will erase data from the connected USB memory device. Exercise caution when using these functions to avoid accidental data loss.

1. Selecting the type of file to delete

Press the CURSOR buttons then the +/YES button or F4 function button (NEXT) to select the type of file to be deleted.

Press the -/NO or F1 function button (BACK) to return to the previous screen.

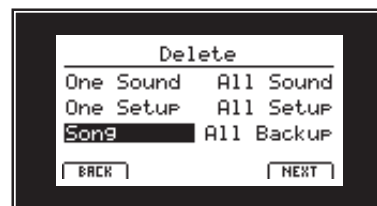

2. Selecting the file to delete

Turn control knob A or press the CURSOR buttons to move the selection cursor. Then press the +/YES button or F4 function button (EXEC) to delete the file.

Press the -/NO or F1 function button (BACK) to return to the previous screen.

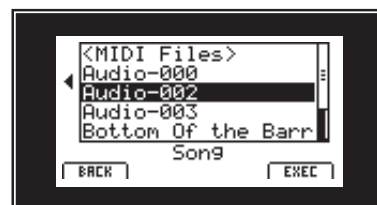

3. Confirming the file deletion

Press the F2 function button (YES) or F3 function button (NO) to confirm or cancel the delete file operation.

After deleting the file, the main USB Menu will screen will be shown in the LCD display.



4 Rename

These functions allow data stored on a USB memory device to be renamed.

1. Selecting the type of file to rename

Press the CURSOR buttons then the +/YES button or F4 function button (NEXT) to select the type of file to be renamed.

Press the -/NO or F1 function button (BACK) to return to the previous screen.

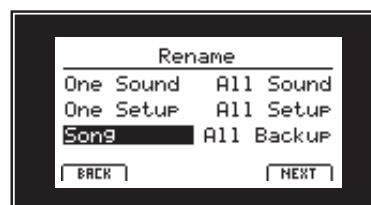

2. Selecting the file to rename

Turn control knob A or press the CURSOR buttons to move the selection cursor. Then press the +/YES button or F4 function button (EXEC) to rename the file.

Press the -/NO or F1 function button (BACK) to return to the previous screen.

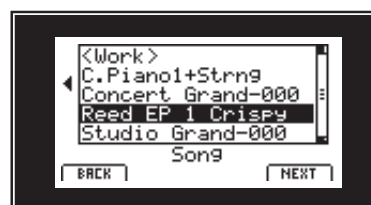

3. Renaming the file

Turn control knobs A and B to move the position of the cursor and change the character, then press the +/YES button or F4 function button (EXEC) to rename the file.

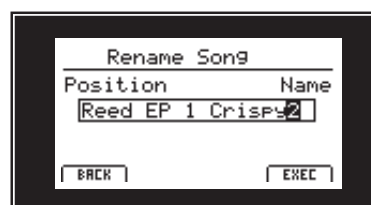

4. Confirming the file rename

Press the F2 function button (YES) or F3 function button (NO) to confirm or cancel the rename file operation.

After renaming the file, the main USB Menu will screen will be shown in the LCD display.

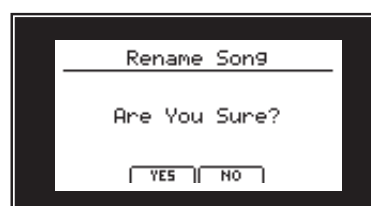

5 Format

This function allows a USB memory device to be formatted, erasing all stored data.



The Format function will erase all data stored on the connected USB memory device. Exercise caution when using this functions to avoid accidental data loss.

1. Selecting the Format function

Press the CURSOR buttons then the +/YES button or F4 function button (NEXT) to select the format function.

Press the -/NO or F1 function button (BACK) to return to the previous screen.

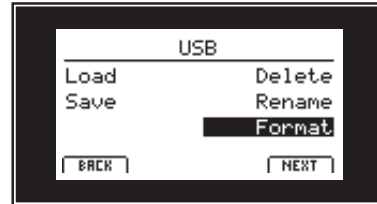

2. First confirmation prompt

The first confirmation prompt will be shown in the LCD display.

Press the +/YES button or F4 function button (EXEC) to select the proceed with the format function.

Press the -/NO or F1 function button (BACK) to return to the previous screen.

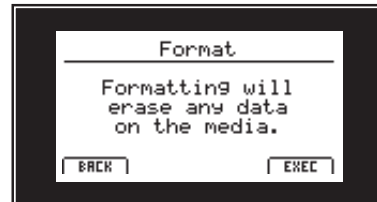

2. Final confirmation prompt

A final confirmation prompt will be shown in the LCD display.

Press the +/YES button or F4 function button (EXEC) to select the proceed with the format function.

Press the -/NO or F1 function button (BACK) to return to the previous screen.

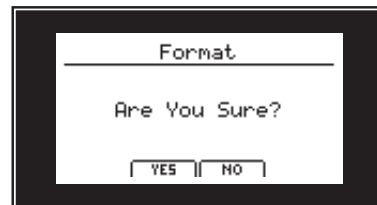

Overview of the SYSTEM Menu

The SYSTEM menu contains parameters and settings that affect the general operation of the MP10. The settings are grouped into four categories: Utility, Offset, User, and Reset, selected using the function buttons. SYSTEM parameters will be memorised automatically upon exiting the menu.

SYSTEM Menu parameters

Category	Parameters
Utility	System Tuning, System Channel, LINE IN Level, Volume Fader Action, LED Brightness, Out Mode, LCD Reverse, LCD Contrast, Foot Switch Mode, Eff. SW Mode, Lock Mode
Offset	EQ Offset ON/OFF, EQ Offset Hi/Mid/Lo, Reverb Offset
User	User Touch Curve, User Temperament
Reset	Reset One Sound, Reset One Setup, Reset System, Reset Recorder, Reset All Sound, Reset All Setup, Reset PowerOn, Factory Reset

Entering the SYSTEM Menu

Press the SYSTEM button.

The LED indicator for the SYSTEM button will turn ON, and the SYSTEM Menu will be shown in the LCD display.



Selecting the SYSTEM parameter category

After entering the SYSTEM Menu:

Press the F1, F2, F3, or F4 function buttons to select the desired SYSTEM parameter category.

Function button	SYSTEM parameter category
F1	Utility
F2	Offset
F3	User
F4	Reset

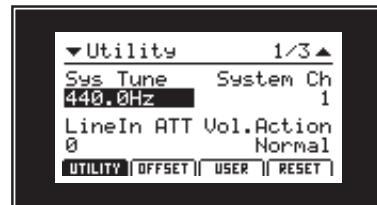

Adjusting SYSTEM parameters

Turn the four control knobs (A, B, C, D) located on either side of the LCD display to adjust the displayed parameters.

Parameters can also be adjusted by using the CURSOR buttons to move the selection cursor, and -/NO or +/YES buttons to decrease or increase the value of the selected parameter.

* Press the CURSOR ▲ or CURSOR ▼ buttons to cycle through the other SYSTEM Menu pages.

Press the EXIT button to exit the SYSTEM Menu and return to the Play Mode screen.

* The adjust SYSTEM parameters will be memorised automatically.

* To prevent data loss, avoid turning the power OFF while the MP10 is saving SYSTEM Menu settings.

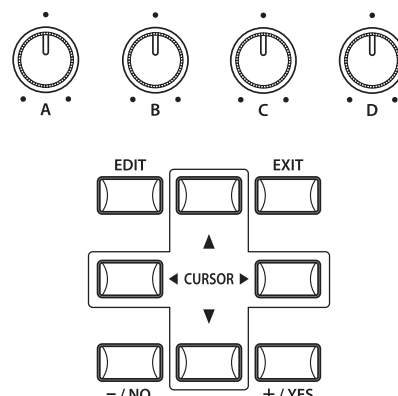

SYSTEM Menu parameters

1 Utility

1. System Tuning

VALUE: 427.0 - 453.0 Hz

This parameter sets the global master tuning of the MP10 in 0.5Hz increments.

* The default setting is A = 440.0 Hz

3. LINE IN Level

VALUE: 0 - 127

This parameter adjusts the gain of the MP10's LINE IN jack. If the output level of the external device is too high, reduce the value of this parameter. Alternatively, if the output is too low, increase the value of this parameter.

5. LED Brightness

LOW/HIGH

This parameter adjusts the brightness of the panel LEDs.

Value	Description
Low	Low brightness, designed for dark stages.
High	High brightness, suitable for brighter ambience.

* The default setting is High

7. LCD Reverse

ON/OFF

This parameter inverts the black and white pixels of the LCD display, which may improve visibility in certain situations.

* The default setting is OFF.

9. Foot Switch Mode

NORMAL/SETUP+/PLAYBACK

This parameter determines the function of the foot switch.

Value	Description
Normal	Foot switch functions as defined in the EDIT Menu.
Setup+	Foot switch selects the next SETUP memory.
Playback	Foot switch starts/stops selected song playback.

* The default setting is Normal.

2. System Channel

VALUE: 1CH - 16CH

This parameter sets the System MIDI channel on which MIDI messages are received when Receive Mode is set to Panel (page 46)

* The default setting is 1ch.

4. Volume Fader Action

NORMAL/CATCH

This parameter determines how the section volume faders affect the volume parameter.

Value	Description
Normal	Volume changes immediately when fader is moved.
Catch	Volume does not change until fader 'catches' the previously stored volume value, thus preventing unexpected volume jumps.

* The default setting is Normal.

6. Out Mode

STEREO/2X MONO

This parameter allows the MP10's Line-out signal to be changed from stereo to dual-mono.

This may be useful in certain situations, allowing one output to be used for a monitor speaker and the other to be plugged into the mixing console.

Value	Description
Stereo	The Line-out signal is normal stereo.
2xMono	The Line-out signal is mono on both jack.

* The default setting is Stereo.

* To avoid unexpected sound issues, stereo effects such as AutoPan will be turned OFF when 2xMono is selected.

8. LCD Contrast

VALUE: 1 - 10

This parameter adjusts the contrast of the LCD display. The contrast becomes sharper as the value increases.

10. Eff. SW Mode

PRESET/TEMP.

This function determines whether the ON/OFF state of the EFX, REVERB, and AMP buttons is recalled when selecting sounds.

Value	Description
Preset	ON/OFF state is recalled when selecting sounds.
Temp.	ON/OFF state is not recalled when selecting sounds.

* The default setting is Preset.

10. Lock Mode

PANEL LOCK/WHEEL LOCK/FSW LOCK/ EXP LOCK

This function determines which panel controls will be locked when the Panel Lock button is pressed.

Value	Description
Panel Lock	All panel operations except for the keyboard, wheels, pedals, and PANEL LOCK button will be locked.
Wheel Lock	Only the Pitch Bench and Modulation wheels are locked.
FSW Lock	Only the assignable footswitch (FSW) is locked.
EXP Lock	Only the expression pedal (EXP) is locked.

* The default setting is Panel Lock.

2 Offset

1. EQ Offset ON/OFF

ON/OFF

This parameter determines whether the EQ offset is turned ON or OFF. This allows a global EQ to be applied independently of the EQ section and therefore any SETUP changes.

Value	Description
ON	EQ Offset is turned ON.
OFF	EQ Offset is turned OFF.

* The default setting is OFF.

2. EQ Offset Lo/Mid/Hi

VALUE: -9dB -+9dB

These parameters set the EQ offset values for the Lo, Mid, and Hi-range frequencies.

Parameter	Description
Lo	The Low-range frequency EQ offset value.
Mid	The Mid-range frequency EQ offset value.
Hi	The High-range frequency EQ offset value.

* The EQ offset values will be added to the EQ section values. The combined EQ values are limited to ± 9 .

3. Reverb Offset

VALUE: 0 (OFF) - 100%

This parameter sets the reverb depth offset.

This allows a global reverb to be applied independently of the PIANO, E.PIANO, or SUB section's reverb depth setting.

* The default setting is 100%.

3 User

The User category contains functions to create custom touch curves and keyboard temperaments.

■ Creating a User Touch Curve

Turn control knob A to select the User1 or User2 touch curve.

Press the ● button (RECORDER CONTROLS).

The User Touch Curve analysis screen will be shown in the LCD display, prompting for the keyboard to be played.

Play the piano dynamically from very soft to very loud, allowing the instrument to examine the personal playing technique.

* It may take more than one attempt to create an accurate User Touch Curve. Reducing the master volume fader to the lowest position often helps.

Press the ● button again.

The velocity range of the playing will be analysed and a new, personalised touch curve created.

Press the ● button again to store the User Touch Curve, or the F3 button (CANCEL) to return to the previous screen.

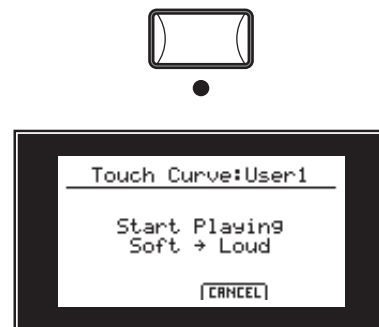

■ Creating a User Temperament

Turn control knob B to select the User1 or User2 temperament.

Press the ● button (RECORDER CONTROLS).

The temperament screen will be shown in the LCD display.

Turn control knob C to select the note to be adjusted.

Turn control knob D to adjust the pitch of the selected note.

* The pitch of each key can be adjusted within the range of -50 - +50 cents.
One semi-tone = 100 cents.

Press the F2 button (SAVE) to store the user temperament, or press the F3 button (CANCEL) to return to the previous screen.

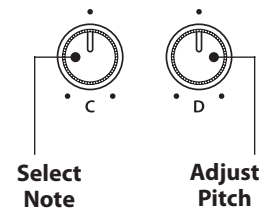
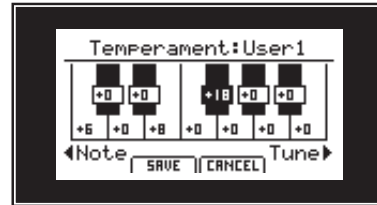
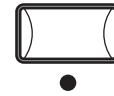

4 Reset

The Reset category contains functions to reset sounds, setups, and settings back to the original factory default.

Use the cursor buttons to select the desired function and +/YES button to execute the operation.



**Once performed, these Reset functions cannot be undone.
Exercise caution when using these functions to avoid accidental data loss.**

1. Reset One Sound

This function resets the currently selected sound to the factory default.

Be careful to select the correct sound before entering the SYSTEM menu and performing this function.

3. Reset System

This function resets all SYSTEM parameters, including MIDI Transmit, Receive, and MMC parameters.

5. Reset All Sound

This function resets all sounds to the factory default.

7. Reset PowerOn

This function resets the PowerOn memory to the factory default.

2. Reset One Setup

This function resets a SETUP memory to the factory default.

Use the SETUP BANK and 1-6 buttons to select the SETUP memory to reset.

4. Reset Recorder

This function resets all internal song recorder memories.

6. Reset All Setup

This function resets all SETUP memories to the factory default.

8. Factory Reset

This function performs a global reset of all sounds, SETUPS, SYSTEM settings, and internal song recorder memories.

Sound List

PIANO section

Concert		Pop		Jazz	
1	Concert Grand	1	Pop Piano	1	Jazz Grand 1
2	Studio Grand	2	Bright Pop Piano	2	Jazz Grand 2
3	Mellow Grand	3	Mellow Pop Piano	3	Standard Grand

E.PIANO section

Tine		Reed		Others	
1	Tine EP 1	1	Reed EP 1	1	Modern EP
2	Tine EP 2	2	Reed EP 2	2	Clavi 1
3	Tine EP 3	3	Reed EP 3	3	Clavi 2

SUB section

Strings		Pad		Others	
1	Hybrid Strings	1	Pad 1	1	Vibraphone
2	Hybrid Ensemble	2	Pad 2	2	Harpichord
3	Beautiful Str.	3	String Pad	3	Choir Ooh/Ahh

Rhythm Pattern List

16 Swing

- | | |
|---|----------------|
| 1 | Funk Shuffle 1 |
| 2 | Funk Shuffle 2 |
| 3 | Hip Hop 1 |
| 4 | Hip Hop 2 |
| 5 | Hip Hop 3 |
| 6 | Hip Hop 4 |
| 7 | 16 Shuffle 1 |
| 8 | 16 Shuffle 2 |
| 9 | 16 Shuffle 3 |

16 Funk

- | | |
|----|--------------|
| 10 | Funky Beat 1 |
| 11 | Funky Beat 2 |
| 12 | Funky Beat 3 |
| 13 | Funk 1 |
| 14 | Funk 2 |
| 15 | Funk 3 |

16 Straight

- | | |
|----|--------------|
| 16 | Jazz Funk |
| 17 | 16 Beat 1 |
| 18 | 16 Beat 2 |
| 19 | 16 Beat 3 |
| 20 | 16 Beat 4 |
| 21 | Ride Beat 4 |
| 22 | Rim Beat |
| 23 | Roll Beat |
| 24 | Light Ride 1 |
| 25 | Dixie Rock |

16 Latin

- | | |
|----|--------------|
| 26 | Surdo Samba |
| 27 | Latin Groove |
| 28 | Light Samba |
| 29 | Songo |
| 30 | Samba |
| 31 | Merenge |

16 Dance

- | | |
|----|--------------|
| 32 | Funky Beat 4 |
| 33 | 16 Beat 5 |
| 34 | Disco 1 |
| 35 | Disco 2 |
| 36 | Techno 1 |
| 37 | Techno 2 |
| 38 | Techno 3 |
| 39 | Heavy Techno |

16 Ballad

- | | |
|----|---------------|
| 40 | Ballad 1 |
| 41 | Ballad 2 |
| 42 | Ballad 3 |
| 43 | Ballad 4 |
| 44 | Ballad 5 |
| 45 | Light Ride 2 |
| 46 | Electro Pop 1 |
| 47 | Electro Pop 2 |
| 48 | 16 Shuffle 4 |

8 Ballad

- | | |
|----|--------------|
| 49 | Slow Jam |
| 50 | 50's Triplet |
| 51 | R&B Triplet |

8 Straight

- | | |
|----|-------------|
| 52 | 8 Beat 1 |
| 53 | 8 Beat 2 |
| 54 | Smooth Beat |
| 55 | Pop 1 |
| 56 | Pop 2 |
| 57 | Ride Beat 1 |
| 58 | Ride Beat 2 |
| 59 | Ride Beat 3 |
| 60 | Slip Beat |

8 Rock

- | | |
|----|-------------|
| 61 | Jazz Rock |
| 62 | 8 Beat 3 |
| 63 | Rock Beat 1 |
| 64 | Rock Beat 2 |
| 65 | Rock Beat 3 |
| 66 | Rock Beat 4 |
| 67 | Blues/Rock |
| 68 | Heavy Beat |
| 69 | Hard Rock |
| 70 | Surf Rock |
| 71 | R&B |

8 Swing

- | | |
|----|----------------|
| 72 | Motown 1 |
| 73 | Fast Shuffle |
| 74 | Motown 2 |
| 75 | Country 2 Beat |

Triplet

- | | |
|----|----------------|
| 76 | Triplet Rock 1 |
| 77 | Triplet Rock 2 |
| 78 | Bembe |
| 79 | Rock Shuffle 1 |
| 80 | Rock Shuffle 2 |
| 81 | Boogie |
| 82 | Triplet 1 |
| 83 | Triplet 2 |
| 84 | Reggae |
| 85 | Gospel Ballad |
| 86 | Waltz |

Jazz

- | | |
|----|--------------|
| 87 | H.H. Swing |
| 88 | Ride Swing |
| 89 | Fast 4 Beat |
| 90 | Afro Cuban |
| 91 | Jazz Waltz 1 |
| 92 | Jazz Waltz 2 |
| 93 | 5/4 Swing |

8 Latin

- | | |
|-----|------------|
| 94 | H.H. Bossa |
| 95 | Ride Bossa |
| 96 | Beguine |
| 97 | Mambo |
| 98 | Cha Cha |
| 99 | Tango |
| 100 | Habanera |

Specifications

■ Kawai MP10 Professional Stage Piano

Keyboard	88 wooden keys with Ivory Touch key surfaces RM3 Grand action with Let-off
Sound Source	Ultra Progressive Harmonic Imaging™ (UPHI)
No. of Sounds	27 voices
Polyphony	max. 192 notes
Sections	Internal: PIANO, E.PIANO, SUB External: MIDI
Effects	Reverb: 7 types EFX: 25 types Amp. Sim: 6 types (E.PIANO section) EQ: 3-band equaliser (mid-frequency range adjust)
Internal Recorder	10 songs - approximately 90,000 note memory capacity
Metronome	Click: 1/4, 2/4, 3/4, 4/4, 5/4, 3/8, 6/8, 7/8, 9/8, 12/8 Rhythm: 100 drum patterns
Internal Memory	SOUND: 27 memories SETUP: 156 memories (6 x 26 banks)
USB Functions	Play Audio: MP3: 32 kHz/44.1 kHz/48 kHz, Mono/Stereo, Bitrate: 8-320 kbit/s (fixed & variable) WAV: 32 kHz/44.1 kHz/48 kHz, Mono/Stereo Record Audio: MP3: 44.1 kHz, 16 bit, Stereo, 192 kbit/s (fixed) WAV: 44.1 kHz, 16 bit, Stereo, 1,411 kbit/s (uncompressed) Load/Save: One Sound, One Setup, SMF, All Sound, All Setup, All Backup Others: Delete, Rename, Format
Storage	USB memory, USB floppy disk drive
Display	128 x 64 pixel LCD with backlight
Jacks	Output: 1/4" Output (L/MONO, R) XLR Output (L, R) with Ground Lift Switch Headphones Input: 1/4" Input (L/MONO, R) MIDI: MIDI IN, MIDI OUT, MIDI THRU USB: USB to Host, USB to Device Foot Control: Damper/Soft, Expression (assignable), Foot Switch (assignable) Power: AC inlet
Power Consumption	25 W
Dimensions (Not including music rack)	1380 (W) x 428 (D) x 185 (H) mm 54 3/8 (W) x 16 7/8 (D) x 7 1/4 (H) in.
Weight	31.8 kg (70.1 lbs)
Included Accessories	Damper/Soft pedal (F-20), Music rack, Power cable, Owner's manual

MIDI Implementation

1 Recognised Data

1. Channel Voice Message

Note off

Status	2nd Byte	3rd Byte
8nH	kkH	vvH
9nH	kkH	00H

n=MIDI channel number :0H-fH(ch.1 ~ ch.16)
kk=Note Number :00H - 7fH(0 ~ 127)
vv=Velocity :00H - 7fH(0 ~ 127)

Note on

Status	2nd Byte	3rd Byte
9nH	kkH	vvH

n=MIDI channel number :0H-fH(ch.1 ~ ch.16)
kk=Note Number :00H - 7fH(0 ~ 127)
vv=Velocity :00H - 7fH(0 ~ 127)

Control Change Bank Select (MSB)

Status	2nd Byte	3rd Byte
BnH	00H	mmH
BnH	20H	llH

n=MIDI channel number :0H-fH(ch.1 ~ ch.16)
mm = Bank Number MSB :00H-7fH (0 ~ 127)
ll = BankNumber LSB :00H-7fH (0 ~ 127)

Modulation

Status	2nd Byte	3rd Byte
BnH	01H	vvH

n=MIDI channel number :0H-fH(ch.1 ~ ch.16)
vv = Modulation depth :00H - 7fH(0 ~ 127) Default = 00H

Data Entry

Status	2nd Byte	3rd Byte
BnH	06H	mmH
BnH	26H	llH

n=MIDI channel number :0H-fH(ch.1 ~ ch.16)
mm,ll=Value indicated in RPN/NRPN :00H - 7fH(0 ~ 127)
*see RPN/NRPN chapter

Volume

Status	2nd Byte	3rd Byte
BnH	07H	vvH

n=MIDI channel number :0H-fH(ch.1 ~ ch.16)
vv=Volume :00H - 7fH(0 ~ 127) Default = 7fH

Panpot

Status	2nd Byte	3rd Byte
BnH	0aH	vvH

n=MIDI channel number :0H-fH(ch.1 - ch.16)
vv=Panpot :00H - 40H - 7fH(left ~center~right) Default = 40H(center)

1. Channel Voice Message (cont.)

Expression			
Status	2nd Byte	3rd Byte	
BnH	0bH	vvH	
n=MIDI channel number		:0H-fH(ch.1 - ch.16)	
vv=Expression		:00H - 7fH(0 - 127)	Default = 7fH
Damper Pedal			
Status	2nd Byte	3rd Byte	
BnH	40H	vvH	
n=MIDI channel number		:0H-fH(ch.1 ~ ch.16)	
vv=Control Value		:00H - 7fH(0 ~ 127)	Default = 00H
0 - 63=OFF, 64 - 127=ON			
Sostenuto Pedal			
Status	2nd Byte	3rd Byte	
BnH	42H	vvH	
n=MIDI channel number		:0H-fH(ch.1 ~ ch.16)	
vv=Control Value		:00H - 7fH(0 ~ 127)	Default = 00H
0 - 63 =OFF, 64 - 127=ON			
Soft Pedal			
Status	2nd Byte	3rd Byte	
BnH	43H	vvH	
n=MIDI channel number		:0H-fH(ch.1 ~ ch.16)	
vv=Control Value		:00H - 7fH(0 ~ 127)	Default = 00H
0 - 63 =OFF, 64 - 127=ON			
Sound controllers #1-9			
Status	2nd Byte	3rd Byte	
BnH	46H	vvH	Sustain Level
BnH	47H	vvH	Resonance
BnH	48H	vvH	Release time
BnH	49H	vvH	Attack time
BnH	4aH	vvH	Cutoff
BnH	4bH	vvH	Decay time
BnH	4cH	vvH	Vibrato Rate
BnH	4dH	vvH	Vibrato Depth
BnH	4eH	vvH	Vibrato Delay
n=MIDI channel number		:0H-fH(ch.1 ~ ch.16)	
vv=Control Value		:00H - 7fH(-64 ~ 0 ~ +63)	Default = 40H
Effect Control			
Status	2nd Byte	3rd Byte	
BnH	5bH	vvH	Reverb depth
n=MIDI channel number		:0H-fH(ch.1 ~ ch.16)	
vv = Control Value		:00H - 7fH(0 ~ 127)	

1. Channel Voice Message (cont.)

NRPN MSB/LSB

Status	2nd Byte	3rd Byte
BnH	63H	mmH
BnH	62H	llH
n=MIDI channel number		:0H-fH(ch.1 ~ ch.16)
mm=MSB of the NRPN parameter number		
ll=LSB of the NRPN parameter number		

NRPN numbers implemented in MP8II are as follows

NRPN # Data

MSB	LSB	MSB	Function & Range		Default
01H	08H	mmH	Vibrato Rate mm	:00H - 7FH(-64 ~ 0 ~ +63)	Default = 40H
01H	09H	mmH	Vibrato Depth mm	:00H - 7FH(-64 ~ 0 ~ +63)	Default = 40H
01H	0aH	mmH	Vibrato Delay mm	:00H - 7FH(-64 ~ 0 ~ +63)	Default = 40H
01H	20H	mmH	Cutoff mm	:00H - 7FH(-64 ~ 0 ~ +63)	Default = 40H
01H	21H	mmH	Resonance mm	:00H - 7FH(-64 ~ 0 ~ +63)	Default = 40H
01H	63H	mmH	Attack time mm	:00H - 7FH(-64 ~ 0 ~ +63)	Default = 40H
01H	64H	mmH	Decay time mm	:00H - 7FH(-64 ~ 0 ~ +63)	Default = 40H
01H	66H	mmH	Release time mm	:00H - 7FH(-64 ~ 0 ~ +63)	Default = 40H

* Ignoring the LSB of data Entry

* It is not affected in case of modifying cutoff if tone does not use the DCF.

RPN MSB/LSB

Status	2nd Byte	3rd Byte
BnH	65H	mmH
BnH	64H	llH
n=MIDI channel number		:0H-fH(ch.1 ~ ch.16)

mm=MSB of the RPN parameter number

ll=LSB of the RPN parameter number

RPN number implemented in MP8II are the followings

RPN # Data

MSB	LSB	MSB	LSB	Function & Range	Default
00H	00H	mmH	llH	Pitch bend sensitivity mm :00H-0cH (0~12 [half tone]),ll:00H	Default=02H
00H	01H	mmH	llH	Master fine tuning mm,ll :20 00H - 40 00H - 60 00H (-8192x50/8192 ~ 0 ~ +8192x50/8192 [cent])	
7fH	7fH	--	--	RPN NULL	

Program Change

Status	2nd Byte
CnH	ppH

n=MIDI channel number :0H-fH(ch.1 ~ ch.16)

pp=Program number :00H - 7fH(0 ~ 127) Default = 00H

Pitch Bend Change

Status	2nd Byte	3rd Byte
EnH	llH	mmH

n=MIDI channel number :0H-fH(ch.1 ~ ch.16)

mm,ll=Pitch bend value :00 00-7f 7fH(-8192~0~+8192) Default = 40 00H

2. Channel Mode message

All Sound OFF

Status	2nd Byte	3rd Byte
BnH	78H	00H

n=MIDI channel number :0H-fH(ch.1 ~ ch.16)

Reset All Controller

Status	2nd Byte	3rd Byte
BnH	79H	00H

n=MIDI channel number :0H-fH(ch.1 ~ ch.16)

All Note Off

Status	2nd Byte	3rd Byte
BnH	7bH	00H

n=MIDI channel number :0H-fH(ch.1 ~ ch.16)

3. System Realtime Message

Status	
FEH	Active sensing

2 Transmitted Data

1. Channel Voice Message

Note off

Status	2nd Byte	3rd Byte
9nH	kkH	00H
n=MIDI channel number		:0H-fH(ch.1 ~ ch.16)
kk=Note Number		:00H - 7fH(0 ~ 127)

Note on

Status	2nd Byte	3rd Byte
9nH	kkH	vvH
n=MIDI channel number		:0H-fH(ch.1 ~ ch.16)
kk=Note Number		:00H - 7fH(0 ~ 127)
vv=Velocity		:00H - 7fH(0 ~ 127)

Control Change

Status	2nd Byte	3rd Byte
BnH	cCH	vvH

* Sending by Assignable Control Knobs

Program Change

Status	2nd Byte	3rd Byte
CnH	ppH	
n=MIDI channel number		:0H-fH(ch.1 ~ ch.16)
pp=Program number		:00H - 7fH(0 ~ 127) Default = 00H

Pitch Bend Change

Status	2nd Byte	3rd Byte
EnH	llH	mmH
n=MIDI channel number		:0H-fH(ch.1 ~ ch.16)
mm,ll=Pitch bend value		:00 00-7f 7fH(-8192~-0~+8192) Default = 40 00H

2. Channel Mode Message

Reset All Controller

Status	2nd Byte	3rd Byte
BnH	79H	00H
n = MIDI channel number		:0H-fH(ch.1 ~ ch.16)
*Sending by [PANIC] function		

All Note Off

Status	2nd Byte	3rd Byte
BnH	7bH	00H
n = MIDI channel number		:0H-fH(ch.1 ~ ch.16)
*Sending by [PANIC] function		

MONO

Status	2nd Byte	3rd Byte
BnH	7eH	mmH
n=MIDI channel number		:0H-fH(ch.1 ~ ch.16)
mm=mono number		:01H(M=1)

POLY

Status	2nd Byte	3rd Byte
BnH	7fH	00H
n=MIDI channel number		:0H-fH(ch.1 ~ ch.16)

3. System Realtime Message

Status

FAH	Start
FBH	Continue
FCH	Stop

*Sending by [TRANSPORT] function

3 Exclusive Data

MMC commands

*Sending by [TRANSPORT] function

*Transmit only

F0 7F <device ID> 06 <command> F7

device ID: 00H - 7FH

command:

01:STOP, 02:PLAY, 03:DEFERRED PLAY, 04:FAST FORWARD, 05:REWIND, 06:RECORD STROBE, 07:RECORD EXIT, 08:RECORD PAUSE, 09:PAUSE, 0A:EJECT, 0B:CHASE, 0C:COMMAND ERROR RESET, 0D:MMC RESET

4 SOUND/SETUP Program/Bank

If the Receive Mode MIDI parameter is set to Panel (page 46), the MP10 receives MIDI data on the System Channel only. To change internal sounds via MIDI, please refer to the SOUND Program Number list below.

* Note: If the MP10 receives the Program Number from 1 to 128 and Bank number MSB 0 or 1 in the System Channel, the MP10 will switch to SETUP mode and the corresponding SETUP is recalled. When the Receive Mode is Section, the MP10 can be received to each internal sound sections individually.

Panel Mode:

SETUP Program Number

BANK#MSB	1:	SETUP mode ON
BANK#LSB	0-25:	BANK A-Z
PROGRAM	0-5:	Setup Variation 1-6

SOUND Program Number

BANK#MSB	0:	SETUP mode OFF
BANK#LSB	0:	PIANO Section
	1:	E.PIANO Section
	2:	SUB Section
PROGRAM	0-8:	Sound variation 1-9

* Only one sound section is activated.

Section Mode:

BANK#MSB	(ignored)
BANK#LSB	(ignored)
PROGRAM	0-8: Sound variation 1-9

*For each section's Receive Channel.

*Not related to Setup ON/OFF.

5 Control Change Number (CC#) Table

Control Number		Control Function
Decimal	Hex	
0	0	Bank Select (MSB)
1	1	Modulation Wheel or lever
2	2	Breath Controller
3	3	(undefined)
4	4	Foot Controller
5	5	Portament Time
6	6	Data Entry (MSB)
7	7	Channel Volume
8	8	Balance
9	9	(undefined)
10	A	Panpot
11	B	Expression Controller
12	C	Effect Controller1
13	D	Effect Controller2
14	E	(undefined)
15	F	(undefined)
16-19	10-13	General Purpose Controller1~4
20-31	14-1F	(undefined)
32	20	Bank Select (LSB)
33-63	21-3F	(LSB of Control Number 1-32)
64	40	Hold1 (Damper Pedal or Sustain)
65	41	Portamento On/Off
66	42	Sostenuto
67	43	Soft Pedal
68	44	Legato Footswitch
69	45	Hold2 (freeze etc)
70	46	Sound Controller1 (Sound Variation)
71	47	Sound Controller2 (Filter Resonance/Harmonic Intensity)
72	48	Sound Controller3 (Release Time)
73	49	Sound Controller4 (Attack Time)
74	4A	Sound Controller5 (Brightness/Cutoff)
75	4B	Sound Controller6 (Decay Time)
76	4C	Sound Controller7 (Vibrato Rate)
77	4D	Sound Controller8 (Vibrato Depth)
78	4E	Sound Controller9 (Vibrato Delay)
79	4F	Sound Controller10
80-83	50-53	General Purpose Controller5~8
84	54	Portament Control
85-90	55-5A	(undefined)
91	5B	Effect1 Depth (Reverb Send Level)
92	5C	Effect2 Depth
93	5D	Effect3 Depth (Chorus Send Level)
94	5E	Effect4 Depth
95	5F	Effect5 Depth
96	60	Data Increment
97	61	Data Decrement
98	62	Non Registered Parameter Number (LSB)
99	63	Non Registered Parameter Number (MSB)
100	64	Registered Parameter Number (LSB)
101	65	Registered Parameter Number (MSB)
102-119	66-77	(undefined/reserved)
120-127	78-7F	Channel Mode Message

MIDI Implementation

■ Kawai MP10 Professional Stage Piano

Date: August 2010 Version: 1.0

Function		Transmit	Receive		Remarks
			Panel	Section	
Basic Channel	Default	1-16	1-16	1-16	
	Changed	1-16	1-16	1-16	
Mode	Default	3	3	3	
	Messages Altered	3, 4 (M=1) *****	X	X	
Note Number:	True Voice	0-127 *****	0-127	0-127	
Velocity	Note ON	O 1-127	O 1-127	O 1-127	
	Note OFF	X	X	X	
After Touch	Key's	X	X	X	
	Ch's	O (*1)	X	X	
Pitch Bend		O	O	O	
Control Change	0, 32	O	O	X	Bank Select
	1	O	O (*2, 3)	O	Modulation
	6, 38	O	X	O	Data Entry
	7	O	X	O	Volume
	10	O	X	O	Panpot
	11	O	O (*2, 3)	O	Expression (EXP)
	64	O	O (*2)	O	Hold1 (Damper)
	66	O	O (*2, 3)	O	Sostenuto (FootSW)
	67	O	O	O	Soft
	70, 71	O	X	O	Sustain, Resonance
	72, 73, 74, 75	O	X	O	RLS, ATK, CTF, DCY
	76, 77, 78	O	X	O	Vibrato (Rate, Depth, Delay)
	91	O	X	O	Reverb Depth
98, 99	X	X	O	NRPN LSB/MSB	
100, 101	X	X	O	RPN LSB/MSB	
0-119	O (*1)	X	X		
Prog Change:	True #	O *****	O 0-127	O 0-127	
System Exclusive		O	X	X	
Common	: Song Position	X	X	X	
	: Song Select	X	X	X	
	: Tune	X	X	X	
System Real Time	: Clock	X	X	X	
	: Commands	O	X	X	
Aux Messages	: All Sound Off	X	O	O	
	: Reset All Controller	O	O	O	
	: Local ON/OFF	X	X	X	
	: All Note OFF	O	O (123-127)	O (123-127)	
	: Active Sense	X	O	O	
: Reset	X	X	X		
Notes	*1: assigned to Modulation Wheel, EXP, FootSW or Knob A-D *2: On/Off settings of each section are set in EDIT menu. *3: The function is assigned to MOD/EXP/FootSW in EDIT menu . (default effect is #01.Mod/#11.Exp/#66Soste)				

"Mode1: OMNI ON, POLY"
"Mode3: OMNI OFF, POLY"

"Mode2: OMNI ON, MONO"
"Mode4: OMNI OFF, MONO"

O: Yes
X: No

Software Update

This page contains instructions for updating the MP10's system software.

Please read these instructions thoroughly before attempting to perform the software update.

■ Checking the software version

To check the current software version installed on the MP10, press and hold the STORE button, then turn the instrument on.

The current software (Program) version will be shown on the first line of the LCD display.

If the Program version number is greater than or equal to the update version, no further action is necessary.

* Turn the instrument off and on to return to normal operation.

If the Program version number is lower than the update version, please continue to follow the instructions below.



1. Prepare the USB memory device

Copy the MP10_040.SYS update file to the root folder of a USB memory device.

* The USB device should be formatted to the 'FAT' or 'FAT32' filesystem.



2. Connect the USB memory device

While the instrument is turned off:

Connect the prepared USB memory device to the USB port.



3. Start the update

Press and hold buttons 4, 5, and 6 in the SETUP section, then turn on the instrument.

The update process will start automatically after a few seconds, and status messages will be shown in the LCD display.

* Do not remove the USB memory device while the software update is in progress.

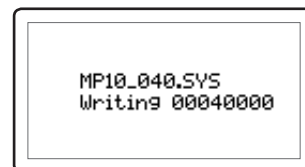
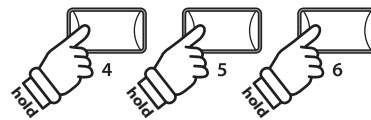

4. Finish the update, disconnect the USB memory device

After approximately 30 seconds, a message will be shown in the LCD display, indicating that the software update has been successful.

Disconnect the USB memory device, then turn the instrument off and on. The updated software will be used automatically.

* If the software update is unsuccessful, restart the process from step 1.

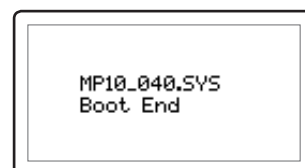



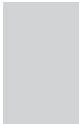

KAWAI

THE FUTURE OF THE PIANO

MP10 Owner's Manual
KPSZ-0035 : 816884
OW1042E-J1107
Version 2
Printed in Indonesia

Copyright © 2011 Kawai Musical Instruments Mfg. Co.,Ltd. All Rights Reserved.