

KAWAI

CLASSIC SERIES CS6 Owner's Manual

Preparation Before Use

Playing the Piano

Music Menu

Recorder

Settings

Appendix

Thank you for purchasing this Kawai Classic Series digital piano.

This owner's manual contains important information regarding the usage and operation of the CS6 digital piano.

Please read all sections carefully, keeping this manual handy for future reference.

Preface

■ About this Owner's Manual

Before attempting to play this instrument, please read the **Preparation Before Use** section from page 10 of this owner's manual. This section explains the name and function of each part, how to connect the power cable, and how to turn on the power.

The **Playing the Piano** section (page 14) provides an overview of the instrument's most commonly used functions, allowing the CS6 digital piano to be enjoyed almost immediately after being connected, while the **Music Menu** section (page 24) includes information regarding the built-in demonstration songs, Piano Music pieces, Lesson and Finger Exercise features, and Concert Magic function.

The **Recorder** section (page 36) provides instructions on how to record and play back pieces stored both in the instrument's internal memory, and also MP3/WAV audio files saved to a USB memory device. The **Settings** section (page 46) details the various options and settings that be used to adjust the sound and operation of the instrument.

Finally, the **Appendix** section (page 83) includes lists for all internal sounds, songs, and drum rhythms, assembly instructions, MIDI reference information, and full specification details.

■ CS6 Feature Highlights

RM3 Grand wooden-key action with Ivory Touch key surface and 'Let-Off' mechanism

This CS6 digital piano utilises Kawai's latest *RM3 Grand* wooden-key action, incorporating various grand piano action characteristics, such as contrasting hammer weights - appropriately graded for each playing range - bass key counterbalancing, and correctly located pivot points for both black and white keys. This unique 'seesaw' movement provides a consistent, evenly balanced action, while finely textured *Ivory Touch* key surfaces not only enhance the enjoyment of playing, but also help to absorb moisture, thus preventing fingers from slipping.

In addition, the CS6 keyboard action is further equipped with a special '*Let-Off*' feature, accurately recreating the subtle 'click' sensation felt when playing the keys of a grand piano very gently.

Ultra Progressive Harmonic Imaging (UPHI) with 88-key piano sampling

This CS6 digital piano captures the beautiful sound of Kawai's highly acclaimed hand-built concert grand piano, with all 88 keys of this exceptional instrument meticulously recorded, analysed and faithfully reproduced using proprietary *Ultra Progressive Harmonic Imaging™* technology. This unique process accurately recreates the broad dynamic range of the original grand piano, affording pianists an extraordinary level of expressiveness ranging from the softest pianissimo to the strongest, boldest fortissimo.

Additional modelling techniques and effects, such as string and damper resonance, and subtle key-release sounds, are also applied, delivering a rich selection of vibrant piano tones with breathtaking realism and authenticity.

USB to Device functionality, with MP3/WAV file recording and playback.

The CS6 digital piano is equipped with USB connectors that not only allow the instrument to be connected to a computer for MIDI use, but also to load and save data to USB memory devices directly. This '*USB to Device*' feature allows songs recorded and stored in internal memory to be saved to USB for posterity, or standard MIDI files (SMF) downloaded from the internet to be conveniently played back without additional hardware.

USB memory devices can also be used to play back MP3 or WAV audio files, allowing musicians to learn the chords or melody for a new piece, or to simply play along with their favourite songs. It is even possible to save performances as MP3 or WAV files for emailing to friends and family, listening to on an iPod, or for further editing using an audio workstation.

Important Safety Instructions

SAVE THESE INSTRUCTIONS

INSTRUCTIONS PERTAINING TO A RISK OF FIRE, ELECTRIC SHOCK, OR INJURY TO PERSONS



WARNING

TO REDUCE THE RISK OF FIRE OR ELECTRIC SHOCK, DO NOT EXPOSE THIS PRODUCT TO RAIN OR MOISTURE.

AVIS : RISQUE DE CHOC ELECTRIQUE - NE PAS OUVRIR.

TO REDUCE THE RISK OF ELECTRIC SHOCK, DO NOT REMOVE COVER (OR BACK). NO USER-SERVICEABLE PARTS INSIDE. REFER SERVICING TO QUALIFIED SERVICE PERSONNEL.



The lightning flash with arrowhead symbol, within an equilateral triangle, is intended to alert the user to the presence of uninsulated "dangerous voltage" within the product's enclosure that may be of sufficient magnitude to constitute a risk of electric shock to persons.



The exclamation point within an equilateral triangle is intended to alert the user to the presence of important operating and maintenance (servicing) instructions in the literature accompanying the product.

Examples of Picture Symbols



denotes that care should be taken.
The example instructs the user to take care not to allow fingers to be trapped.



denotes a prohibited operation.
The example instructs that disassembly of the product is prohibited.



denotes an operation that should be carried out.
The example instructs the user to remove the power cord plug from the AC outlet.

Read all the instructions before using the product.

- 1) Read these instructions.
- 2) Keep these instructions.
- 3) Heed all warnings.
- 4) Follow all instructions.
- 5) Do not use this apparatus near water.
- 6) Clean only with dry cloth.
- 7) Do not block any ventilation openings. Install in accordance with the manufacturer's instructions.
- 8) Do not install near any heat sources such as radiators, heat registers, stoves, or other apparatus (including amplifiers) that produce heat.
- 9) Do not defeat the safety purpose of the polarized or grounding-type plug. A polarized plug has two blades with one wider than the other. A grounding type plug has two blades and a third grounding prong. The wide blade or the third prongs are provided for your safety. If the provided plug does not fit into your outlet, consult an electrician for replacement of the obsolete outlet.
- 10) Protect the power cord from being walked on or pinched particularly at plugs, convenience receptacles, and the point where they exit from the apparatus.
- 11) Only use attachments/accessories specified by the manufacturer.
- 12) Use only with the cart, stand, tripod, bracket, or table specified by the manufacturer, or sold with the apparatus. When a cart is used, use caution when moving the cart/apparatus combination to avoid injury from tip-over. 
- 13) Unplug this apparatus during lightning storms or when unused for long periods of time.
- 14) Refer all servicing to qualified service personnel. Servicing is required when the apparatus has been damaged in any way, such as power-supply cord or plug is damaged, liquid has been spilled or object have fallen into the apparatus, the apparatus has been exposed to rain or moisture, does not operate normally, or has been dropped.

WARNING - When using electric products, basic precautions should always be followed, including the following.



WARNING

Indicates a potential hazard that could result in death or serious injury if the product is handled incorrectly.

The product should be connected to an AC outlet of the specified voltage.



- If you are going to use an AC power cord, make sure that its has the correct plug shape and conforms to the specified power voltage.
- Failure to do so may result in fire.

Do not insert or disconnect the power cord plug with wet hands.



Doing so may cause electric shock.

Take care not to allow any foreign matter to enter the product.

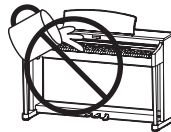

Entry of water, needles or hair pins may result in breakdown or short-circuit. The product shall not be exposed to dripping or splashing. No objects filled with liquids, such as vases, shall be placed on the product.

The chair must be used properly (it must be used only when playing the product).

- Do not play with it or stand on it.
- Only one person is allowed to sit on it.
- Do not sit on it when opening the lid.
- Re-tighten the bolts occasionally.

Doing so may cause the chair to fall over or your fingers to be trapped, resulting in injury.

When using the headphones, do not listen for long periods of time at high volume levels.

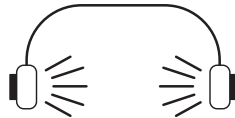

Doing so may result in hearing problems.

Do not lean against the keyboard.

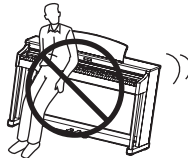

Doing so may cause the product to fall over, resulting in injury.

Do not disassemble, repair or modify the product.

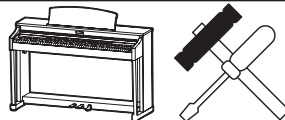

Doing so may result in product breakdown, electric shock or short-circuit.

When disconnecting the AC power cord's plug, always hold the plug and pull it to remove it.



- Pulling the AC power cord itself may damage the cord, causing a fire, electric shock or short-circuit.

The product is not completely disconnected from the power supply even when the power switch is turned off. If the product will not be used for a long time, unplug the AC power cord from the AC outlet.



- Failure to do so may cause fire in case of lightning.
- Failure to do so may over-heat the product, resulting in fire.

This product may be equipped with a polarized line plug (one blade wider than the other). This is a safety feature. If you are unable to insert the plug into the outlet, contact an electrician to replace your obsolete outlet. Do not defeat the safety purpose of the plug.

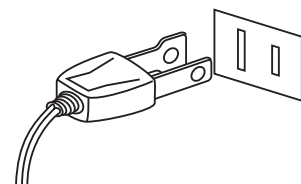

This product shall be near the AC outlet and the power cord plug in a position so that it can readily be disconnected in an emergency because electricity is always charging while the plug is in the AC outlet even in a power switch off condition.



CAUTION

Indicates a potential hazard that could result in injury or damage to the product or other property if the product is handled incorrectly.

Do not use the product in the following areas.

- Areas, such as those near windows, where the product is exposed to direct sunlight
- Extremely hot areas, such as near a heater
- Extremely cold areas, such as outside
- Extremely humid areas
- Areas where a large amount of sand or dust is present
- Areas where the product is exposed to excessive vibrations

Using the product in such areas may result in product breakdown. Use the product only in moderate climates (not in tropical climates).

When you close the keyboard cover, close it gently.



Closing it roughly may trap your fingers, resulting in injury.

Before connecting cords, make sure that the power to this product and other devices is turned OFF.

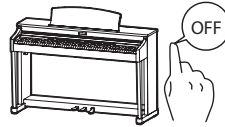

Failure to do so may cause breakdown of this product and other devices.

Do not drag the product on the floor. Take care not to drop the product.

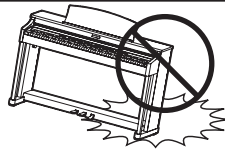

Please lift up the product when moving it. Please note that the product is heavy and must be carried by more than two persons. Dropping the product may result in breakdown.

Do not place the product near electrical appliances such as TVs and radios.

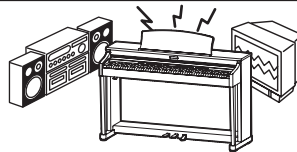

- Doing so may cause the product to generate noise.
- If the product generates noise, move the product sufficiently away from the electrical appliance or connect it to another AC outlet.

When connecting the AC power cord and other cords, take care not to get them tangled.



Failure to do so may damage them, resulting in fire, electric shock or short-circuit.

Do not wipe the product with benzene or thinner.



- Doing so may result in discoloration or deformation of the product.
- When cleaning the product, put a soft cloth in lukewarm water, squeeze it well, then wipe the product.

Do not stand on the product or exert excessive force.



- Doing so may cause the product to become deformed or fall over, resulting in breakdown or injury.

Do not place naked flame, such as lighted candles on the product.

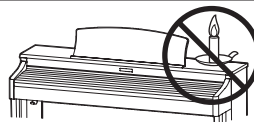

Doing so may cause the illumination to fall over, resulting in fire.

Ensure that the ventilation is not impeded by covering the ventilation openings with items, such as newspaper, table-cloths, curtains, etc.

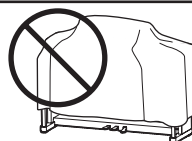

Failure to do so may over-heat the product, resulting in fire.

The product should be located so that its location or position does not interfere with its proper ventilation. Ensure a minimum distance of 5cm around the product for sufficient ventilation.

The product should be serviced by qualified service personnel when:

- The power supply cord or the plug has been damaged.
- Objects have fallen, or liquid has been spilled into the product.
- The product has been exposed to rain.
- The product does not appear to operate normally or exhibits a marked change in performance.
- The product has been dropped, or the enclosure damaged.

Notes on Repair

Should an abnormality occur in the product, immediately turn the power OFF, disconnect the power cord plug, and then contact the shop from which the product was purchased.

CAUTION:

To prevent electric shock, match wide blade of plug to wide slot, fully insert.

ATTENTION:

Pour éviter les chocs électriques, introduire la lame la plus large de la fiche dans la borne correspondante de la prise et pousser jusqu'au fond.



An information on Disposal for users

If your product is marked with this recycling symbol it means that, at the end of its life, you must dispose of it separately by taking it to an appropriate collection point. You should not mix it with general household waste. Disposing of this product correctly will prevent potential negative effects on the environment and human health which could otherwise arise due to inappropriate waste handling. For further details, please contact your local authority. (European Union only)

Instruction for AC power cord (U.K.)

IMPORTANT

THE WIRES IN THIS MAINS LEAD ARE COLOURED IN ACCORDANCE WITH THE FOLLOWING CODE.

- BLUE : NEUTRAL
- BROWN : LIVE

As the colours of the wires in the mains lead of this apparatus may not correspond with the coloured markings identifying the terminals in your plug, proceed as follows:
The wire which is coloured BLUE must be connected to the terminal which is marked with the letter N or coloured BLACK.
The wire which is coloured BROWN must be connected to the terminal which is marked with the letter L or coloured RED.
Do not plug either terminal of the power cord to the the ground od AC outlet on the wall.

Canadian Radio Interference Regulations

This instrument complies with the limits for a class B digital apparatus, pursuant to the Radio Interference Regulations, C.R.C., c. 1374.

FCC Information (U.S.A)

CAUTION : Changes or modifications not expressly approved by the party responsible for compliance could void the user's authority to operate the equipment.

NOTE : This equipment has been tested and found to comply with the limits for a Class B digital device, pursuant to Part 15 of the FCC Rules. These limits are designed to provide reasonable protection against harmful interference in a residential installation. This equipment generates, uses and can radiate radio frequency energy and, if not installed and used in accordance with the instructions, may cause harmful interference to radio communications. However, there is no guarantee that interference will not occur in a particular installation. If this equipment does cause harmful interference to radio or television reception, which can be determined by turning the equipment off and on, the user is encouraged to try to correct the interference by one or more of the following measures:

- Reorient or relocate the receiving antenna.
- Increase the separation between the equipment and receiver.
- Connect the equipment into an outlet on a circuit different from that to which the receiver is connected.
- Consult the dealer or an experienced radio/TV technician for help.



Declaration of Conformity

Products :	Electronic Piano
Model Number :	CS6
Responsible Party Name :	Kawai America Corporation
Address :	2055 East University Drive Rancho Dominguez, CA 90220
Telephone	310-631-1771

This device complies with Part 15 of the FCC Rules. Operation is subject to the following two conditions:

- (1) this device may not cause harmful interference, and
- (2) this device must accept any interference received, including interference that may cause undesired operation.

The nameplate label is located on the underside of the instrument, as indicated below.

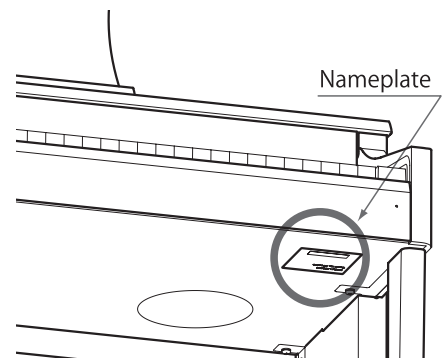

This applies only to products distributed by Kawai America Corporation.

Table of Contents

Preface	3	Concert Magic	32
Important Safety Instructions	4	1 Performing a Concert Magic song	32
Table of Contents	8	2 Concert Magic demo mode	33
Preparation Before Use		3 Concert Magic song arrangement types	34
Part Names and Functions	10	4 Steady Beat mode	35
Setting Up the Piano	12	Recorder	
Adjusting the Volume / Using Headphones ..	13	Song Recorder (Internal memory)	36
Playing the Piano		1 Recording a song	36
Selecting Sounds	14	2 Playing back a song	38
Using the Pedals	15	3 Erasing a part/song	39
Reverb	16	Audio Record/Playback (USB memory)	40
Effects	17	1 Recording an audio file	40
Adjusting Effect Settings	18	2 Playing an audio file	42
Dual Mode	19	3 Playing a song file	44
Split Mode	20	4 Converting a song to an audio file	45
Four Hands Mode	21	Settings	
Metronome / Drum Rhythms	22	Functions menus	46
Registration Memories	23	Basic Settings	47
Music Menu		1 Key Transpose	48
Demo Songs	24	2 Song Transpose	48
Piano Music	25	3 Tone Control	49
Lesson Function	26	4 Speaker Volume	50
1 Selecting a lesson book/song	26	5 Phones Volume	50
2 Listening to the selected lesson song	27	6 Tuning	51
3 Practicing left and right-hand parts separately ..	28	7 Damper Hold	51
4 Repeating sections of a lesson song	29	8 Four Hands	52
5 Recording a lesson song practice	30	9 User Memory	52
6 Finger Exercises	31	10 Factory Reset	53

Virtual Technician	54
1 Touch	55
2 Voicing	57
3 Damper Resonance	58
4 String Resonance	59
5 Key-off Effect	60
6 Stretch Tuning	60
7 Temperament	61
8 Key of Temperament	63
Key Settings	64
1 Lower Octave Shift	65
2 Lower Pedal	65
3 Layer Octave Shift	66
4 Layer Dynamics	67
About MIDI	68
MIDI Settings	70
1 MIDI Channel (transmit/receive)	70
2 Send Program Change Number	71
3 Local Control	71
4 Transmit Program Change Numbers	72
5 Multi-timbral Mode	73
6 Channel Mute	74
USB MIDI (USB to Host connector)	75
USB Menu	76
1 Load Song	77
2 Save Song	78
3 Rename	79
4 Delete	80
5 Format	81
Power Setting menu	82
1 Auto Power Off	82

Appendix

Troubleshooting	83
Connecting to Other Devices	84
Sound List	86
Demo Song List	87
Drum Rhythm List	88
Program Change Number List	89
Assembly Instruction	91
Specifications	94
MIDI Implementation Chart	95

Part Names and Functions

Preparation Before Use

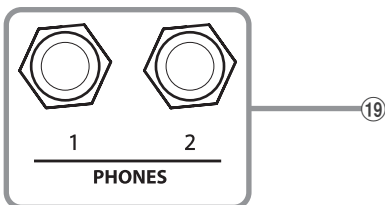
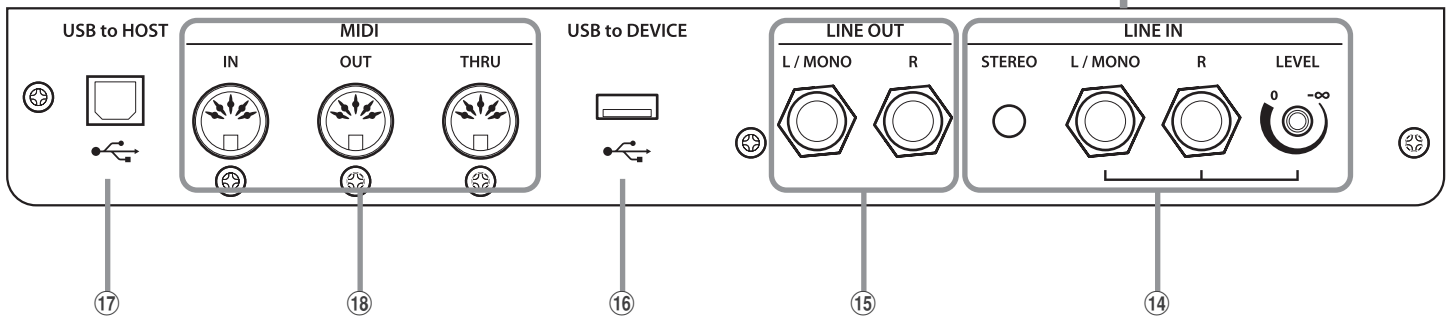
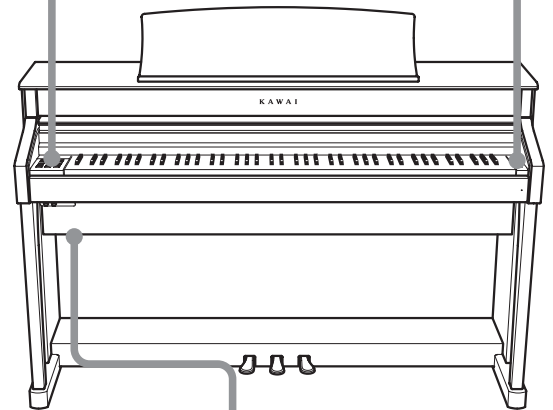
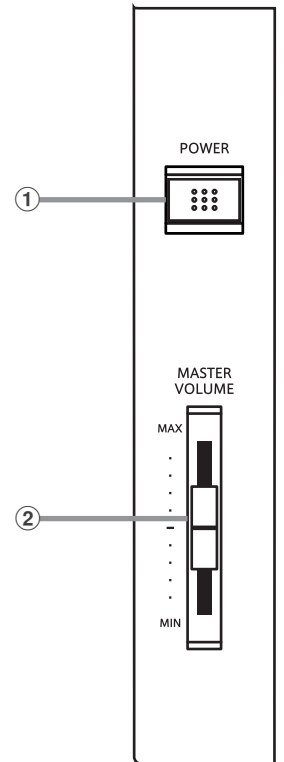
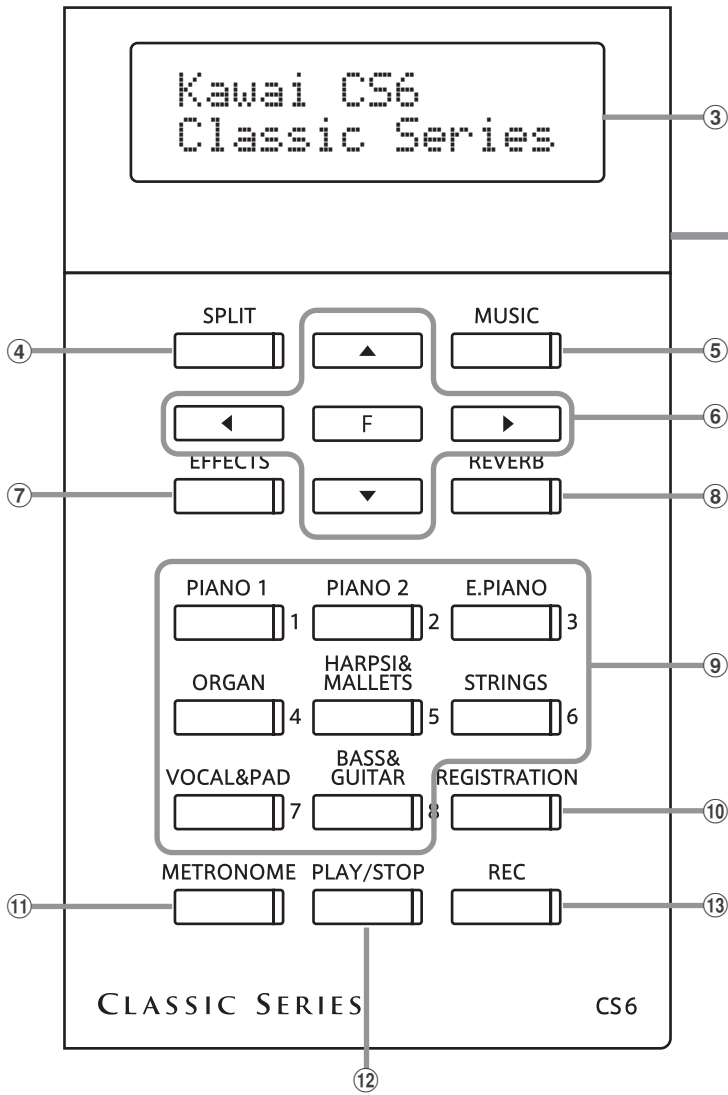

① POWER switch

This switch is used to turn the CS6 digital piano on/off. Be sure to turn off the instrument after playing.

② MASTER VOLUME slider

This slider controls the master volume level of the CS6 digital piano's built-in speakers or headphones, if connected.

③ LCD display

The LCD display provides useful information such as the currently selected sound name, settings values, and the status of other functions when active.

** A protective plastic film is attached to the display during production. Please remove this film before attempting to play the instrument.*

④ SPLIT button

This button activates the SPLIT function, dividing the keyboard into upper and lower sections, and allowing separate sounds to be assigned to each.

⑤ MUSIC button

This button provides access to the built-in demonstration songs, Piano Music pieces, Lesson and Finger Exercises, and Concert Magic function.

⑥ ARROW KEYS / FUNCTION button

These buttons are used to navigate around the various menus and screens, adjust values, and answer on-screen prompts.

⑦ EFFECTS button

This button is used to turn effects for the selected sound on/off, to select the different effect types, and to adjust their settings.

⑧ REVERB button

This button is used to turn reverb for the selected sound on/off, to select the different reverb types, and to adjust their settings.

⑨ SOUND SELECTION buttons

These buttons are used to select the sound(s) that will be heard when playing the keyboard of the CS6 digital piano. Multiple sounds are assigned to each category button, and can be selected by pressing the same button repeatedly.

In addition, these buttons are also used to select Registration memories, and control various other features.

⑩ REGISTRATION button

This button is used to store and recall one of the eight different registration memories. Each registration can store sound, reverb and effects settings, as well as various other panel options.

⑪ METRONOME button

This button is used to turn the metronome function on/off, and also to adjust the tempo, time signature (or beat), and volume settings.

⑫ PLAY/STOP button

This button is used to start/stop the playback of demonstration songs, Piano Music pieces, and Lesson and Finger Exercises, and to start/stop the recording and playback of recorder songs, and MP3/WAV audio files.

⑬ REC button

This button is used to record performances to internal memory or a USB memory device as MP3/WAV audio files.

When using the Lesson or Finger Exercises function, this button is also used to record practices, allowing comparison with the built-in songs and etudes.

⑭ LINE IN jacks

These jacks are used to connect the stereo output (Left/Right 1/4" phone or 1/8" mini plug) from audio equipment, computers, or other electronic instruments to the CS6 digital piano's amplifier and speakers.

When using the Left/Right 1/4" phone jacks, the input level can be adjusted by using the LEVEL knob.

⑮ LINE OUT jacks

These jacks are used to connect the stereo output (Left/Right 1/4" phone plug) of the CS6 digital piano to external amplifiers, mixers, recording devices, and similar equipment.

⑯ USB TO DEVICE port

This port allows USB memory devices to be connected to the CS6 digital piano.

⑰ USB TO HOST port

This port allows the CS6 digital piano to be connected to a computer using a USB 'B to A' type cable in order to send and receive MIDI data.

⑱ MIDI IN / OUT / THRU jacks

These jacks are used to connect the CS6 digital piano to external MIDI devices such as other musical instruments or a computer in order to send and receive MIDI data.

⑲ PHONES jacks

These jacks are used to connect stereo headphones to the CS6 digital piano. Two pairs of headphones can be connected and used simultaneously.

Setting Up the Piano

1. Connecting the power cable to the instrument

Connect the included power cable to the 'AC IN' inlet located on the back side of instrument.

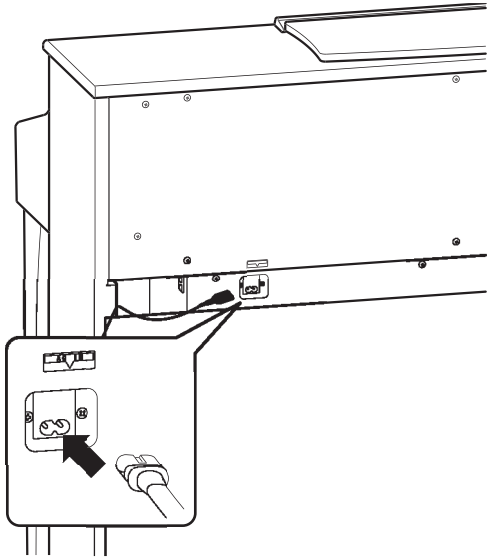

2. Connecting the power cable to an outlet

Connect the instrument's power cable to an AC outlet.

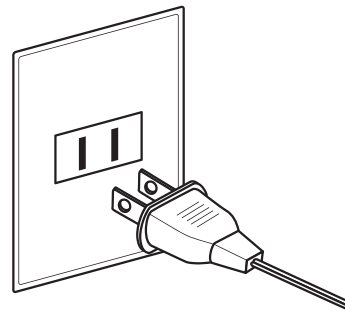

3. Turning on the power

Press the POWER SWITCH located on the right hand side of the front panel.

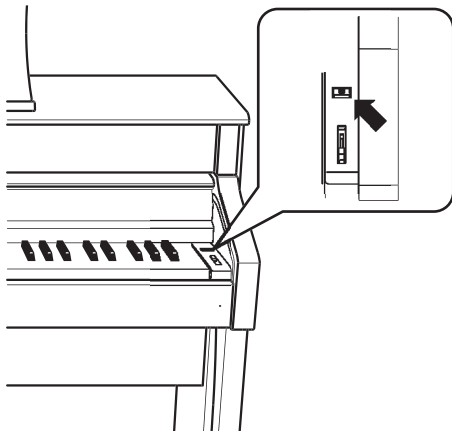

The instrument will turn on, and the words 'Concert Grand' will be shown in the LCD display, indicating that the Concert Grand sound is selected, and the CS6 digital piano is ready to be played.

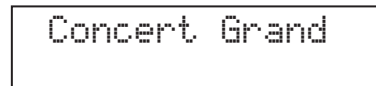

The CS6 features a power saving function that can automatically turn off the instrument after a specified period of inactivity. For more information, please refer to the Auto Power Off setting on page 82.

■ Adjusting the pedal support bolt

A pedal support bolt is attached at the base of the pedal board to aid stability when the pedals are pushed. Turn the bolt anti-clockwise until it makes contact with the floor and supports the pedals firmly.

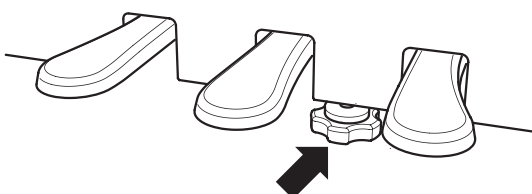

Adjusting the Volume / Using Headphones

■ Adjusting the volume

The MASTER VOLUME slider controls the volume level of the instrument's speakers, or headphones if connected.

Move the slider up to increase the volume, and down to decrease the volume.

Use this slider to set the volume to a comfortable listening level - the middle is often a good starting point.

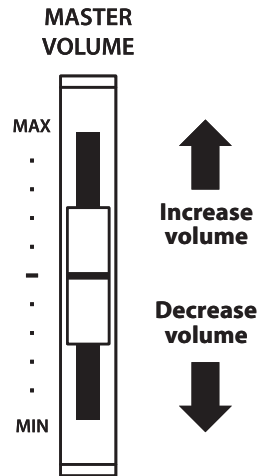

■ Using headphones

Use the jacks located beneath the keyboard on the left hand side, to connect stereo headphones to the CS6 digital piano.

Two pairs of headphones can be connected and used simultaneously.

When a pair of headphones is connected, sound will not be produced by the speakers.

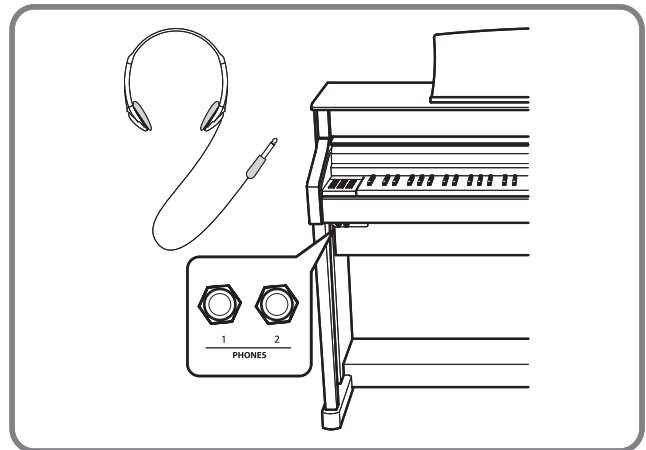

■ Attaching the headphone hook (optional)

A headphone hook is included with the CS6 digital piano and can be used to hang headphones when not in use.

If desired, attach the headphone hook to the underside of the keyboard as shown in the illustration opposite.

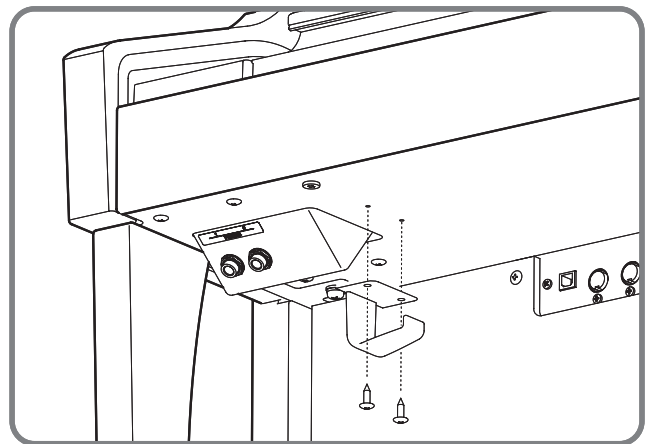

Selecting Sounds

The CS6 digital piano features a wide selection of realistic instrument sounds suitable for various musical styles. Sounds are arranged into eight categories, with several sounds assigned to each category button. For a complete listing of sounds available on the CS6 instrument, please refer to page 86 of this owner's manual.

By default, the 'Concert Grand' sound will be selected automatically when the instrument is turned on.

■ Selecting a sound

Press the desired SOUND SELECT button.

The LED indicator for the button will turn on to indicate that this category has been selected, and the name of the sound will be shown in the LCD display.

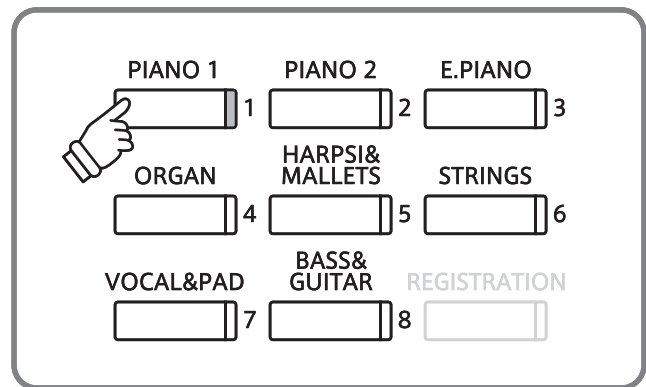
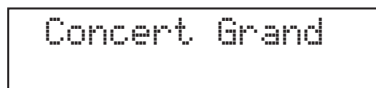

■ Changing the sound

Several sounds are assigned to each category button.

Press the selected category button repeatedly to cycle through the different sound variations.

The ▲ and ▼ buttons can also be used to select sounds.

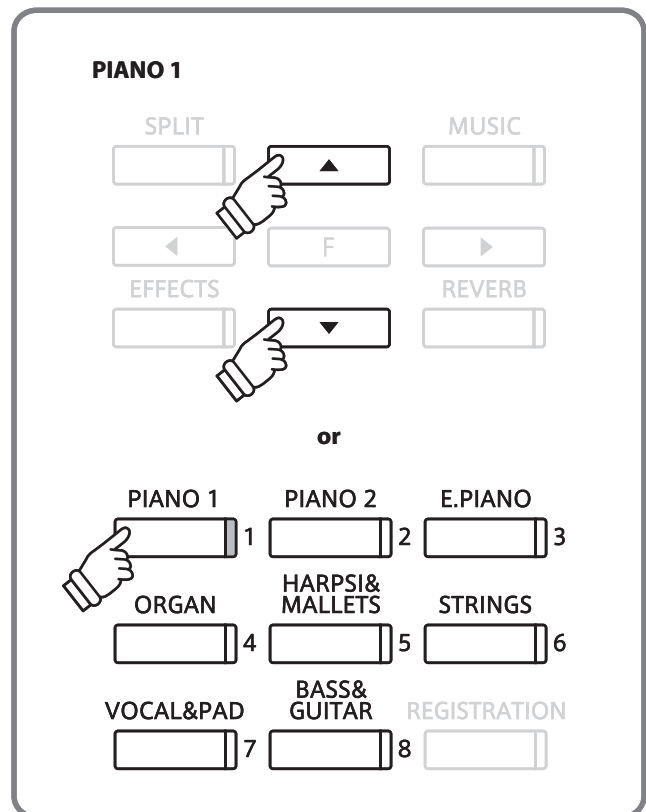

Using the Pedals

As with a grand piano, the CS6 digital piano features three pedals: sustain, sostenuto, and soft.

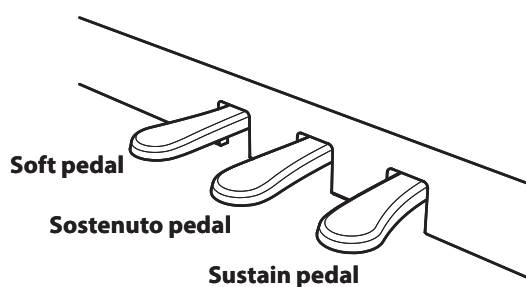

■ Sustain pedal (right pedal)

Depressing this pedal sustains the sound after one's hands have been lifted from the keyboard - greatly enriching the piano sound, while also assisting smooth 'legato' passages.

The sustain pedal is capable of responding to half pedaling.

■ Soft pedal (left pedal)

Depressing this pedal softens the sound, reducing its volume.

When the rotary speaker effect is selected, the soft pedal is also used to alternate the speed of the rotary simulation between 'Slow' and 'Fast' effect modes.

■ Sostenuto pedal (centre pedal)

Depressing this pedal after playing the keyboard and before releasing the keys, sustains the sound of only those notes that have been played. Any keys that are subsequently played after the sostenuto pedal is depressed will not be sustained.

■ Pedal support bolt

If the pedal support bolt does not make contact with the floor, the pedal board may become damaged. Ensure that this bolt is fully extended and supports the pedals firmly.



When moving the instrument, always adjust or remove the pedal support bolt, then readjust when the instrument is in its new position.

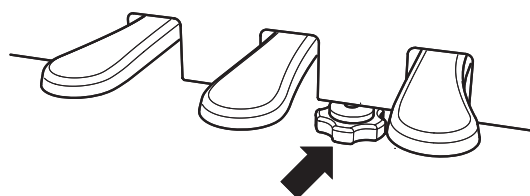

■ Caring for the pedals

If the surface of the pedals becomes dirty, clean the pedals using a dry dish-washing sponge. Do not attempt to clean the pedals using rust-removing solvents, abrasives or files.

Reverb

Reverb adds reverberation to the sound, simulating the acoustic environment of a recital room, stage, or concert hall. The CS6 digital piano features five different reverb types.

■ Reverb types

Reverb type	Description
Room 1	Simulates the ambiance of a living room or small rehearsal room.
Room 2	Simulates a larger room than Room 1.
Stage	Simulates the ambiance of a small hall or live stage.
Hall 1	Simulates the ambiance of a concert hall or theater.
Hall 2	Simulates a larger hall or theater than Hall 1.

■ Turning reverb on/off

Press the REVERB button to turn reverb on/off.

The LED indicator for the REVERB button will turn on to indicate that reverb is in use.

The currently selected reverb type and status will be shown in the LCD display.

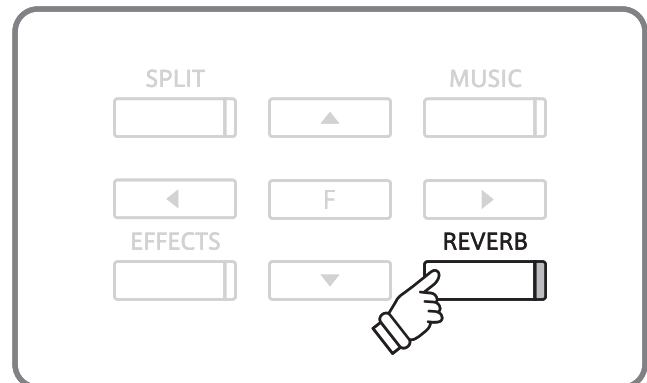
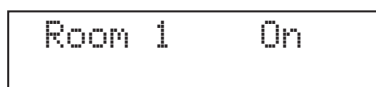

■ Changing the reverb type

Press and hold the REVERB button, then press the ▲ or ▼ button to cycle through the different reverb types.

Release the REVERB button to select the desired reverb type.

After a few seconds, the LCD display will return to showing the name of the selected sound.

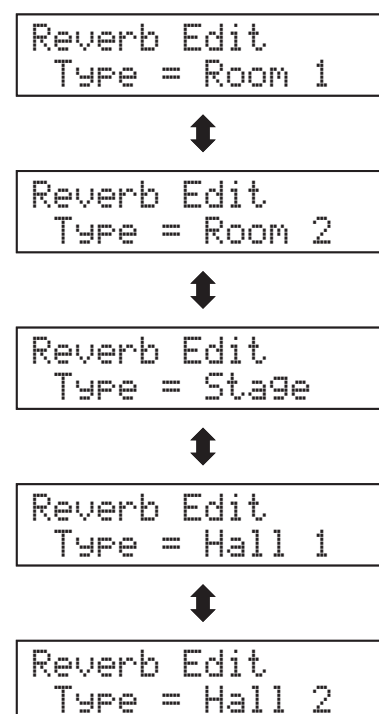
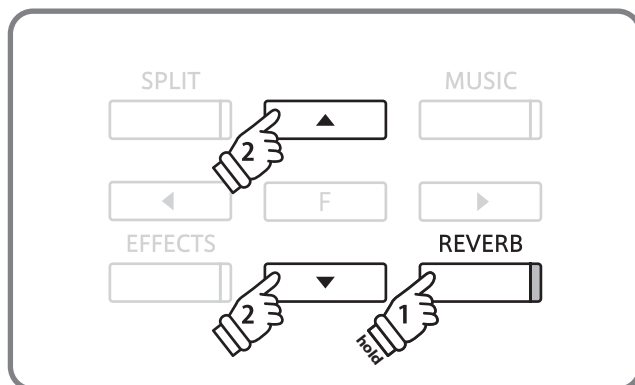

Effects

In addition to reverb, various other effects can be applied to the selected sound, altering the tonal character and feeling of the instrument. The CS6 digital piano features seven effect types.

Effect types

Effect type	Description
Chorus	Simulates the rich character of a vocal choir or string ensemble, by layering a slightly detuned version of the selected sound over the original, thus enriching the tonal character.
Delay 1 / 2 / 3	Adds an echo to the selected sound. There are three types of delay available, each with a different length of delay between the echoes.
Tremolo	Adds vibrato to the sound.
Rotary 1 / 2	Simulates the sound of a rotary speaker cabinet commonly used with electronic organs. Rotary 1 is a normal rotary effect, while Rotary 2 adds distortion. * The soft pedal can be used to alternate the speed of the rotary simulation between 'Slow' and 'Fast' effect modes.

Turning effects on/off

Press the EFFECTS button to turn the effects on/off.

The LED indicator for the EFFECTS button will turn on to indicate that the effects are in use.

The currently selected effect type and status will be shown in the LCD display.

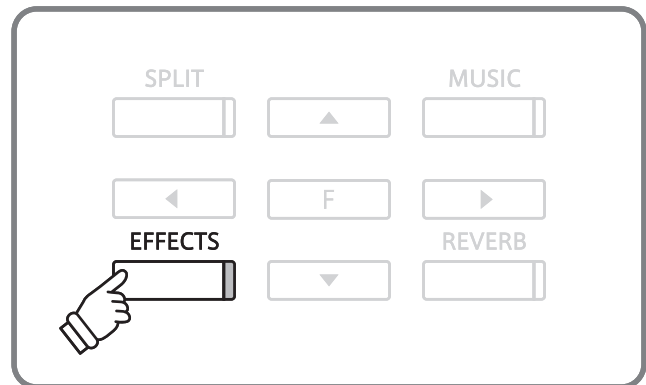
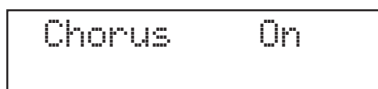

Changing the effect type

Press and hold the EFFECTS button, then press the ▲ or ▼ button to cycle through the different effect types.

Release the EFFECTS button to select the desired effect type.

After a few seconds, the LCD display will return to showing the name of the selected sound.

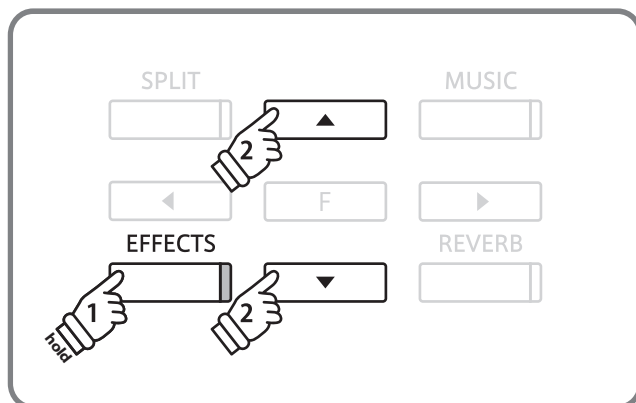

Effect Edit
Type = Chorus



Effect Edit
Type = Delay 1



Effect Edit
Type = Delay 2



Effect Edit
Type = Delay 3



Adjusting Effect Settings

It is also possible to adjust settings for each effect, further altering the tonal character of the selected sound.

Effect settings and explanation

Effect type	Adjustable settings	Explanation
Chorus	Depth	Adjusts the depth (strength) of the Chorus effect.
	Speed	Adjusts the speed of the Chorus effect.
Delay 1 / 2 / 3	Depth	Adjusts the depth (strength) of the Delay effect.
	Time	Adjusts the time (length) of the Delay effect.
Tremolo	Depth	Adjusts the depth (strength) of the Tremolo effect.
	Rate	Adjusts the rate (speed) of the Tremolo effect.
Rotary 1 / 2	Acceleration Speed	Adjusts the acceleration speed of the Rotary effect.
	Rotary Speed ('Fast' rotary mode only)	Adjusts the speed of the Rotary effect.

Entering the effect settings menu

Press and hold the EFFECTS button, then press the ▲ or ▼ buttons to cycle through the different effect types.

Release the EFFECTS button to select the desired effect type.

Press the FUNCTION button to enter the effect settings menu.

The effect settings menu will be shown in the LCD display.

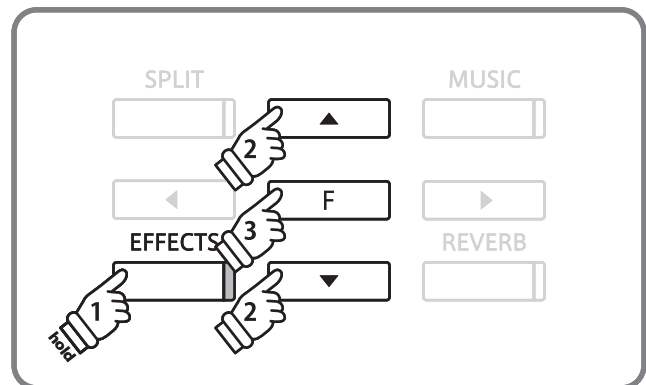

Adjusting effect settings

Press the ◀ or ▶ buttons to select the effect setting, then press the ▲ or ▼ buttons to increase or decrease the setting's value.

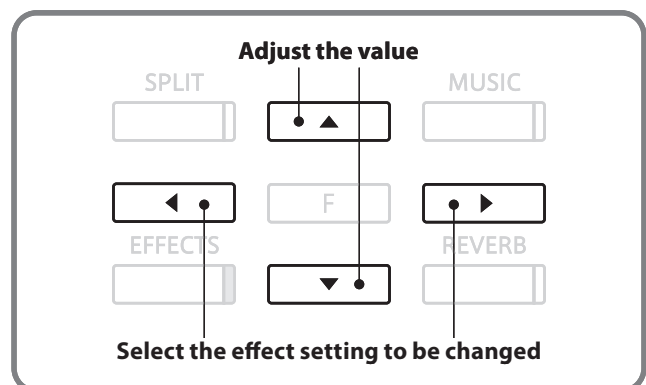
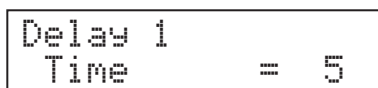

Exiting the effect settings menu

Press the FUNCTION button to exit the effect settings menu and return to the previous screen.

Press a SOUND SELECT button to return to showing the name of the selected sound.

Dual Mode

The Dual Mode function allows two sounds to be layered together, creating a more complex sound. For example, a piano sound layered with strings, or an electric piano combined with a choir, etc.

■ Entering dual mode

Press and hold a SOUND SELECT button, then press another SOUND SELECT button.

The LED indicators for both buttons will turn on to indicate that the two sounds have been selected, and their names will be shown in the LCD display.

The sound assigned to the button that is pressed first will be shown on the top line.

For example, to layer a piano sound with strings, first press and hold the PIANO 1 button, then press the STRINGS button.

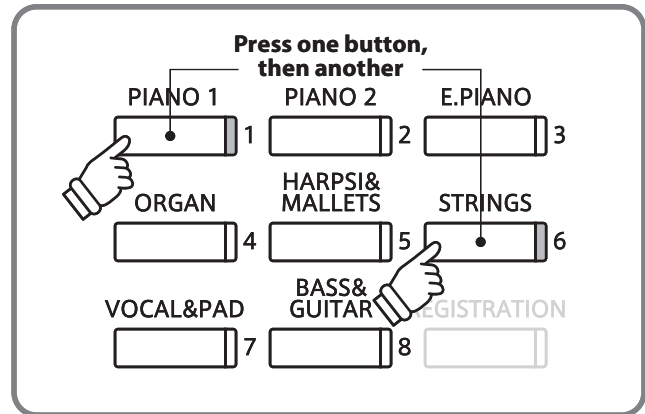
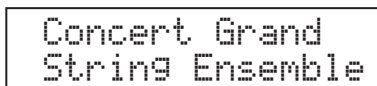

■ Changing layered sounds

Press and hold a SOUND SELECT button, then press another SOUND SELECT button repeatedly to select the other sounds assigned to that button.

For example, to change the layered String Ensemble sound to Slow Strings, first press and hold the PIANO 1 button, then press the STRINGS button repeatedly until 'Slow Strings' is shown on the bottom line of the LCD display.

To layer two sounds assigned to the same SOUND SELECT button, first press a SOUND SELECT button to select the initial sound, then press and hold the same SOUND SELECT button, and finally press the ▲ or ▼ buttons to select the desired layered sound.

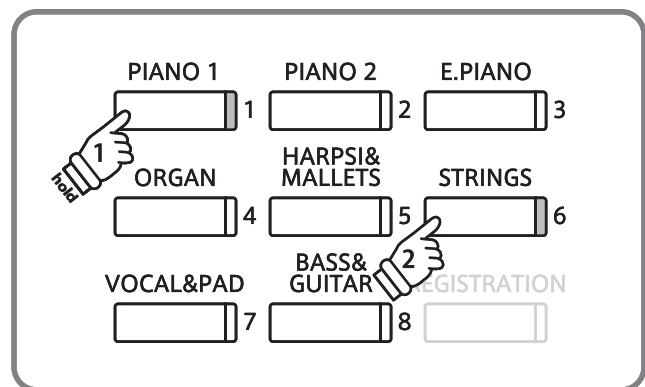

■ Adjusting the volume balance

Press the ◀ or ▶ buttons to adjust the volume balance between the two layered sounds.

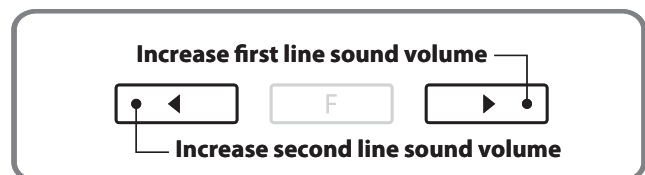
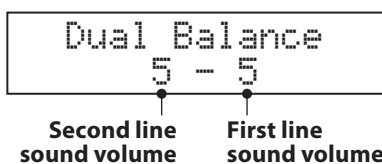

■ Exiting dual mode

Press a SOUND SELECT button to exit dual mode.

The name of the selected sound will be shown in the LCD display.

Split Mode

The Split Mode function divides the keyboard into two sections, allowing each section to be played with a different sound. For example, a bass sound in the lower section, and a piano sound in the upper section.

■ Entering split mode

Press the SPLIT button.

The LED indicator for the SPLIT button will turn on to indicate that split mode has been enabled. In addition, the LED indicator for the upper section sound will also turn on, while the LED indicator for the lower section sound will start to flash.

The name of the upper section and lower section sounds will also be shown in the LCD display, with a slash symbol (/) indicating that split mode is in use.

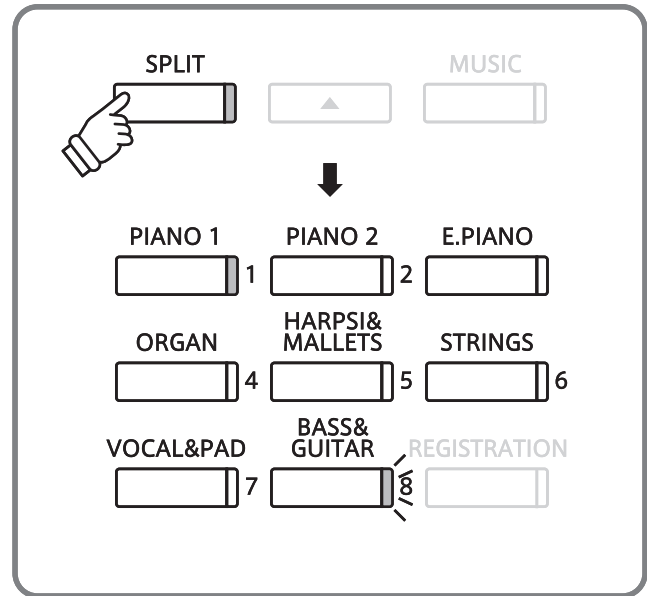

■ Changing the upper/lower section sound

Press a SOUND SELECT button to select the desired sound for the upper section.

Press and hold the SPLIT button, then press a SOUND SELECT button to select the desired sound for the lower section.

■ Changing the split point

Press and hold the SPLIT button, then press a key on the keyboard.

The name of the pressed key will be shown in the LED display, and will become the new split point.

* The default split point is set between keys B2 and C3.

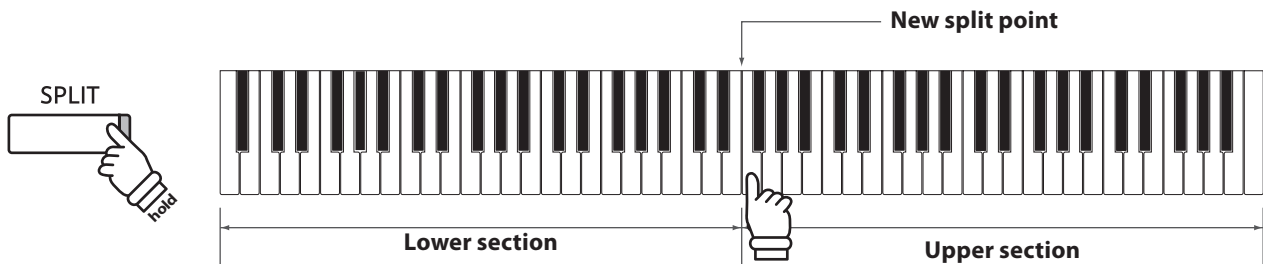

■ Exiting split mode

Press the SPLIT button to exit split mode.

The LED indicator for the SPLIT button will turn off, and the name of the selected sound will be shown in the LCD display.

Four Hands Mode

The Four Hands Mode function divides the keyboard into two sections in a similar way to that of the Split Mode function. However, the octave/pitch of each section is also adjusted, while the sustain (right) pedal and soft (left) pedal act as separate sustain pedals for the upper and lower sections respectively.

With Four Hands Mode enabled, the CS6 digital piano can be used as two separate 44-key instruments, allowing two people to perform piano duets within the same key range using the same instrument.

■ Entering four hands mode

Press and hold the SPLIT button, then press the sustain (right) and soft (left) pedals simultaneously.

The LED indicator for the SPLIT button will start to flash to indicate that four hands mode has been enabled.

The name of the upper section and lower section sounds will also be shown in the LCD display, with a slash symbol (/) indicating that four hands mode is in use.

* The 'Concert Grand' sound will be selected automatically for both sections.

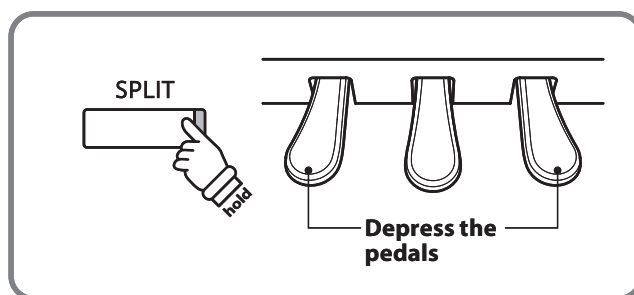
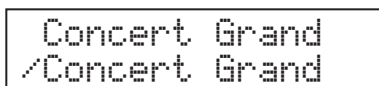

* The pitch of the upper section will be lowered by two octaves, while the pitch of the lower section will be raised by two octaves.

* Four Hands Mode can also be enabled by using the setting in the 'Basic Settings' Functions menu (page 52).

■ Changing the upper/lower section sound

Press a SOUND SELECT button to select the desired sound for the upper section.

Press and hold the SPLIT button, then press a SOUND SELECT button to select the desired sound for the lower section.

■ Changing the split point

Press and hold the SPLIT button, then press a key on the keyboard.

The name of the pressed key will be shown in the LED display, and will become the new split point.

■ Adjusting the upper/lower section volume

Press the the ◀ or ▶ buttons to adjust the volume balance between the upper and lower sections.

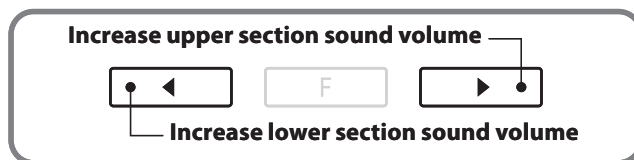
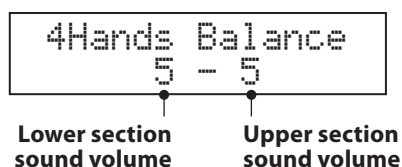

* Four hands mode and split mode are separate functions - changes made to four hands mode will not affect split mode, and vice versa.

■ Exiting four hands mode

Press the SPLIT button to exit four hands mode.

The LED indicator for the SPLIT button will turn off, and the name of the selected sound will be shown in the LCD display.

Metronome / Drum Rhythms

The Metronome function provides a steady beat to aid practicing the piano at a consistent tempo. In addition to regular metronome beats, the CS6 digital piano also features a variety of drum rhythms to accompany most playing styles and musical genres.

■ Turning the metronome on/off

Press the METRONOME button.

The LED indicator for the METRONOME button will turn on to indicate that the metronome is in use, and a 1/4 beat will start to count. The tempo in beats per minute (bpm) will also be shown in the LCD display.



Press the METRONOME button again to stop the metronome. The LED indicator for the METRONOME button will turn off.

■ Adjusting the metronome tempo, changing the time signature/drum rhythm

Press the METRONOME button to start the metronome, then press the ▲ or ▼ buttons to increase or decrease the tempo.

* The metronome tempo can be adjusted within the range of 10-400 bpm (20-800 bpm for eighth note rhythms).

Press the ◀ or ▶ buttons to select the desired time signature.

* There are ten different types of time signature available: 1/4, 2/4, 3/4, 4/4, 5/4, 3/8, 6/8, 7/8, 9/8, and 12/8.

Alternatively, one of the 100 drum rhythms can be selected instead of a simple metronome count.

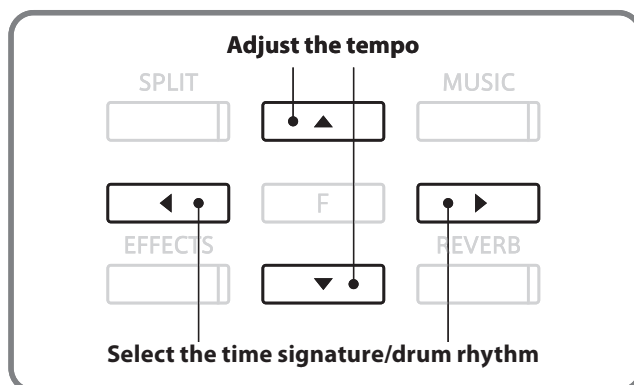

* Please refer to page 88 for a complete listing of available drum rhythms.

■ Adjusting the metronome/rhythm volume

While the metronome tempo is shown in the LCD display:

Press and hold the METRONOME button, then press the ▲ or ▼ buttons to increase or decrease the metronome volume.

The metronome volume level will be shown in the LCD display.

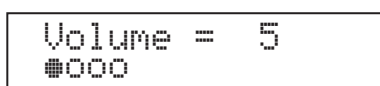

* The metronome volume can be adjusted within the range of 1-10.

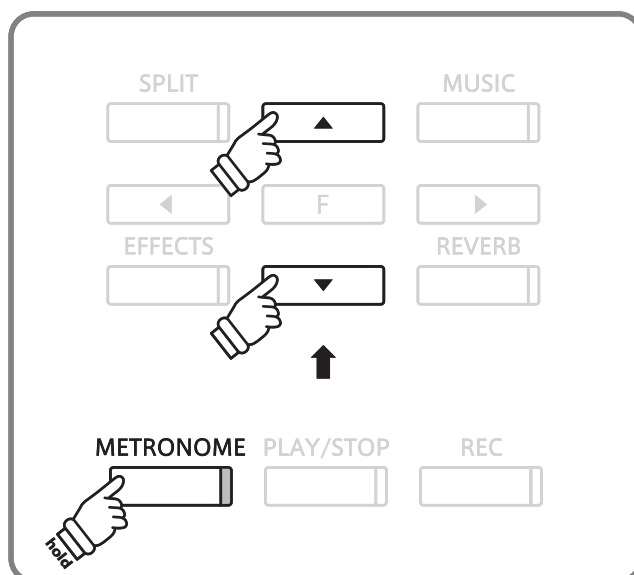

Registration Memories

The Registration function allows the current instrument setup (sound selections, split point, reverb and effect settings, and various other panel options) to be stored in one of eight registration memories, and conveniently recalled at the touch of a button.

■ Settings stored in registration memories

Sound settings	Tone settings
Selected sound (including dual and split mode settings)	Tone Control
Effect and Reverb settings	Tuning
Virtual Technician settings	Damper Hold on/off
Touch Curve	Keyboard settings
Voicing	Lower Octave Shift
Damper Resonance	Lower Pedal on/off
String Resonance	Layer Octave Shift
Key-off Effect	Layer Dynamics
Stretch Tuning	
Temperament	

■ Selecting a registration

Press the REGISTRATION button.

The LED indicator for the REGISTRATION button will turn on to indicate that the registration function is in use, and the sound(s) for the currently selected registration memory will be shown in the LCD display.

Press one of the REGISTRATION SELECT buttons (i.e. SOUND SELECT buttons) numbered from 1-8 to select a memory.

Press the REGISTRATION button to return to normal operation.

The LED indicator for the REGISTRATION button will turn off.

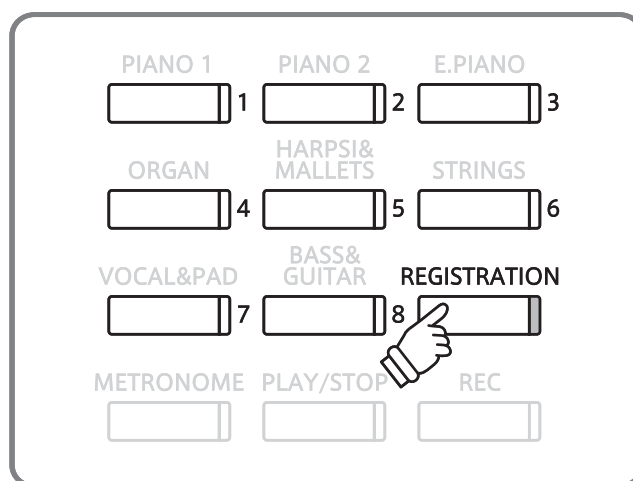

■ Storing a registration

Press and hold the REGISTRATION button for a few seconds.

The REGISTRATION (SOUND) SELECT buttons will start to flash.

Press one of the REGISTRATION (SOUND) SELECT buttons to select the memory in which to store the new registration.

A beep will sound to confirm that the registration has been stored in the selected memory.

Save Regist to
Select 1 - 8



■ Resetting all registrations

Press and hold the REGISTRATION and PLAY/STOP buttons, then turn the instrument's power off/on.

All registrations will be reset to the factory default settings.

Demo Songs

The Demo function provides an excellent introduction to the varied capabilities of CS6 digital piano. There are 36 different demonstration songs available, highlighting the instruments' rich selection of high quality sounds and its power speaker system. For a complete listing of demonstration songs, please refer to page 87 of this owner's manual.

■ Entering demo mode

Press the MUSIC button.

The LED indicator for the MUSIC button will start to flash, and the Music Menu will be shown in the LCD display. Demo mode will be selected automatically.

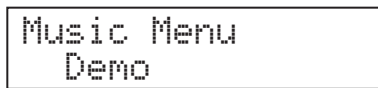

Press the FUNCTION or PLAY/STOP buttons.

The LED indicator for the PIANO 1 button will start to flash, and the 'Concert Grand' demo song will start to play.

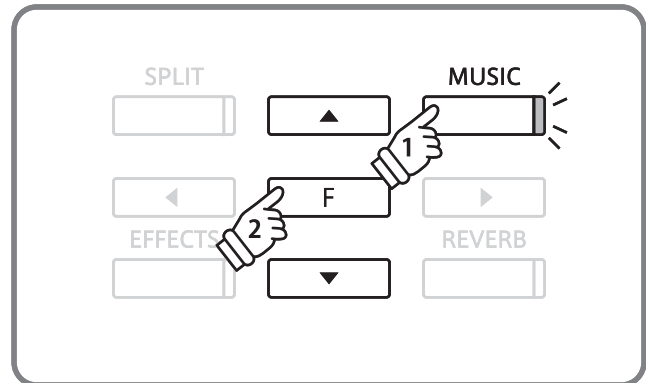

■ Selecting a demo song

While Demo mode is selected:

Press a SOUND SELECT button.

The first demo song of the sound category will start to play.

Press the ▲ or ▼ buttons to cycle through the demo songs in the selected sound category, and the ◀ or ▶ buttons to cycle through the different sound categories.

The demo song will start to play, and the name of the selected sound will be shown in the LCD display.

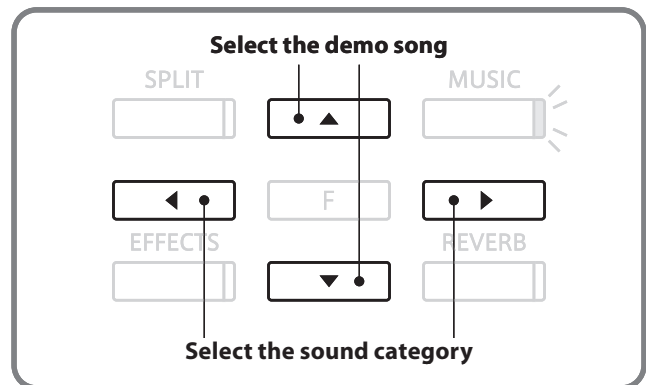

■ Stopping the demo song and exiting demo mode

Press the PLAY/STOP button while the song demo is playing.

The LED indicator for the selected SOUND SELECT button will stop flashing, and the the song demo will stop playing.

Press the MUSIC button.

The LED indicator for the MUSIC button will stop flashing and the name of the selected sound will be shown in the LCD display.

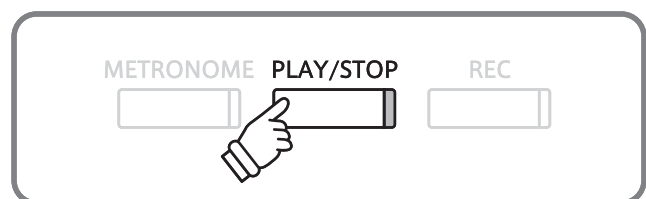

Piano Music

In addition to the sound demonstration songs, the CS6 digital piano also features a selection of popular classical piano works from the Baroque and Romantic periods. Notated scores are provided in the separate 'Classical Piano Collection' book*, assisting the musical appreciation and study of each piece. For a complete listing of Piano Music pieces, please refer to the separate 'Internal Song Lists' booklet.

* Depending on market area.

■ Entering piano music mode

Press the MUSIC button, then press the ▲ or ▼ buttons until Piano Music is shown in the LCD Display.

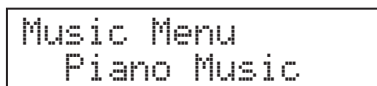

Press the FUNCTION or PLAY/STOP buttons.

The LED indicator for the PLAY/STOP button will turn on, and the song 'Tamourin' by Rameau will start to play.

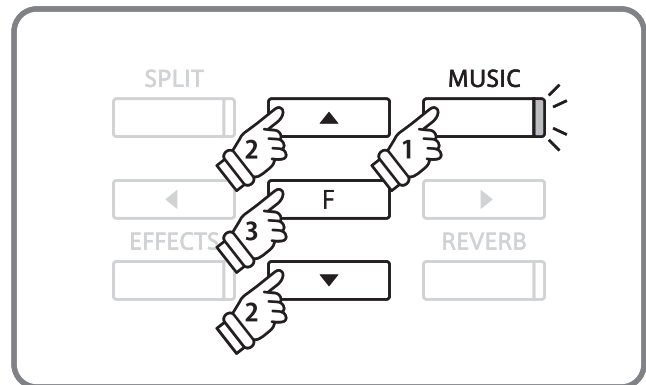

■ Selecting a piano music song

While Piano Music mode is selected:

Press the ▲ or ▼ buttons to cycle through piano music songs.

The song title and composer name are shown on the top and bottom lines of the LCD display respectively.

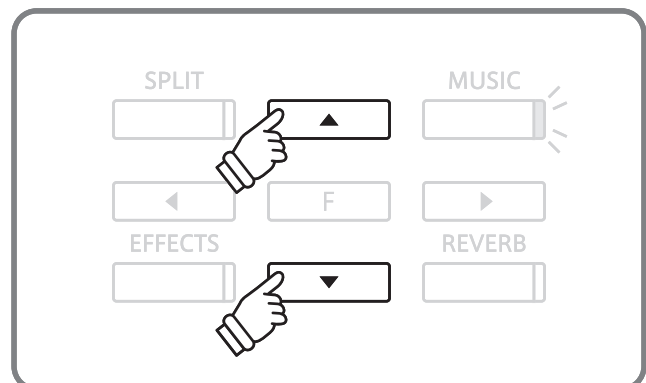

■ Replaying the piano music song

Press the PLAY/STOP button to replay the piano music song.

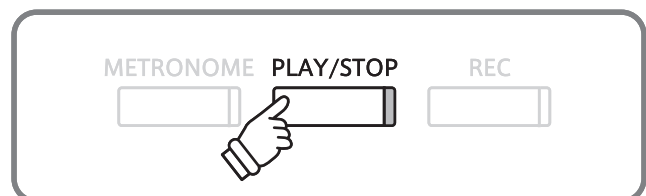

■ Stopping the piano music song and exiting piano music mode

Press the PLAY/STOP button while the song is playing.

The LED indicator for the PLAY/STOP button will turn off and the selected piano music song will stop playing.

Press the MUSIC button.

The LED indicator for the MUSIC button will stop flashing and the name of the selected sound will be shown in the LCD display.

Lesson Function

The Lesson function allows budding pianists to practice the piano using a selection of built-in song books and finger exercises. The left and right hand parts of each piece can be practiced separately, adjusting the tempo to perfect difficult passages, before being recorded for self-evaluation.

Built-in lesson mode song books

US, Canada, UK, Australasia	Rest of the World
Alfred's Basic Piano Library Lesson Book Level 1A	Burgmüller 25 (25 Etudes Faciles, Opus 100)
Alfred's Basic Piano Library Lesson Book Level 1B	Czerny 30 (Etudes de Mécanisme, Opus 849)
Alfred's Basic Adult Piano Course Lesson Book Level 1	Czerny 100 (Hundert Übungsstücke, Opus 139)
Alfred's Premier Piano Course Lesson 1A	Beyer (Vorschule im Klavierspiel, Opus 101)
Alfred's Premier Piano Course Lesson 1B	J.S. Bach: Inventionen, Sonatinen Album 1

* Lesson books sold separately - please refer to the separate 'Internal Song Lists' booklet for more information.

1 Selecting a lesson book/song

Entering lesson mode

Press the MUSIC button, then press the ▲ or ▼ buttons until Lesson Mode is shown in the LCD Display.

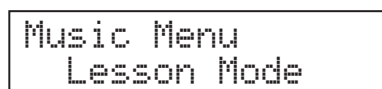

Press the FUNCTION button to enter lesson mode.

The name of the selected lesson book and song will be shown in the LCD display.

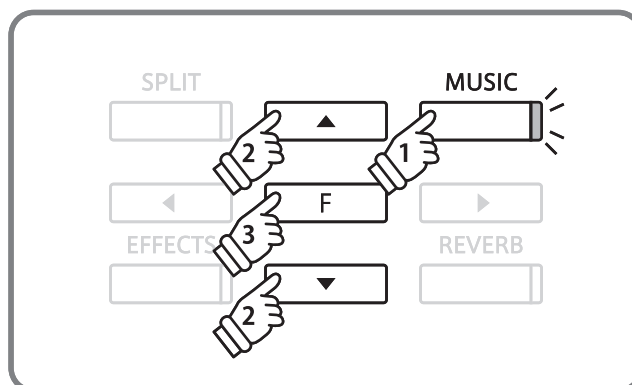

Selecting a lesson book/song

While Lesson mode is selected:

Press the FUNCTION button to cycle through the available lesson books, then press the ▲ or ▼ buttons to select the desired song.

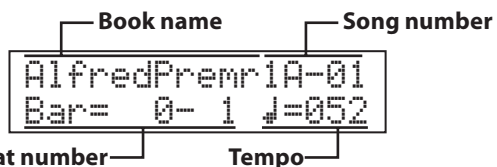

It is also possible to select songs by pressing and holding the MUSIC button, then pressing the relevant key on the keyboard.

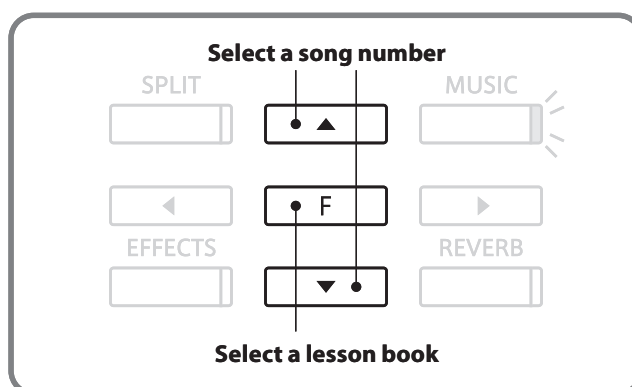

* Please refer to the separate 'Internal Song Lists' booklet for a complete listing of available lesson books/songs and corresponding key numbers.

2 Listening to the selected lesson song

This page will explain how to play and stop the selected lesson song, and adjust the tempo.

■ Playing the lesson song

After selecting a lesson book and song:

Press the PLAY/STOP button.

The LED indicator for the PLAY/STOP button will turn on, and a one bar count-in will be heard before the song starts to play.

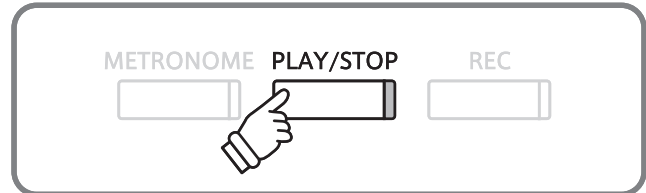
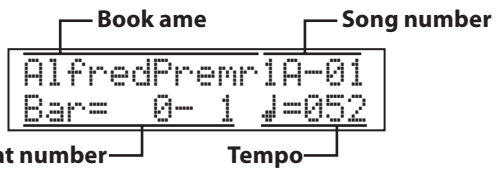

* If the first bar of the song begins on an 'up' beat (i.e. pickup notes), the first bar number will be shown as zero in the LCD display.

* The metronome will not continue after the count-in bar, but can be turned on manually by pressing the METRONOME button.

■ Changing the tempo of the lesson song

Press and hold the METRONOME button, then press the ▲ or ▼ buttons to increase or decrease the lesson song tempo.

Press the ▲ and ▼ buttons simultaneously to reset the lesson song tempo back to the default value.

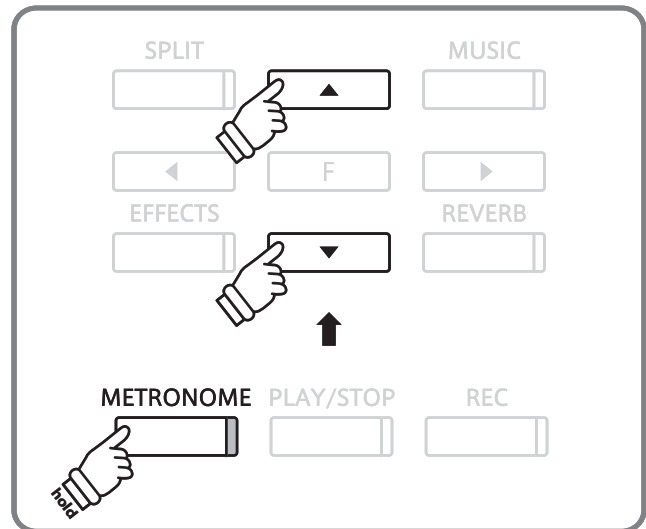

■ Stopping and resuming the lesson song

Press the PLAY/STOP button again to stop the lesson song.

Press the PLAY/STOP button once again.

A one bar count-in will be heard before the lesson song resumes playback from the previous position.

Press the PLAY/STOP button to stop the lesson song, then press the EFFECTS and REVERB buttons simultaneously to reset the playing position to the first bar.

■ Exiting lesson mode

Press the MUSIC button.

The LED indicator for the MUSIC button will stop flashing and the name of the selected sound will be shown in the LCD display.

3 Practicing left and right-hand parts separately

This page will explain how to adjust the left and right-hand part volume of the selected lesson song (allowing each part to be practiced separately), and how to start playing a lesson song from a specific bar.

■ Adjusting the left/right-hand part volume

After selecting a lesson book and song:

Press the ◀ or ▶ buttons to adjust the volume of the left/right-hand part volume.

Increasing the volume of the left-hand part will reduce the volume of the right-hand part, and vice versa.



Left-hand part volume Right-hand part volume

Press the PLAY/STOP button.

A one bar count-in will be heard before the song starts to play with the left/right-hand part volume settings applied.

Adjust the volume of the right-hand part



Adjust the volume of the left-hand part

* To practice the right-hand part while listening to the left-hand part, set the left-hand volume to 9.

* To practice the left-hand part while listening to the right-hand part, set the right-hand volume to 9.

* If the Beyer lesson book is selected, increasing the left-hand value will decrease the volume of the student's part, while increasing the right-hand value will decrease the volume of the teacher's part.

■ Playing the lesson song from a specific bar

Press the REVERB or EFFECTS buttons to advance or rewind the starting bar of the selected lesson song.

Press and hold the REVERB or EFFECTS buttons to fast-forward or fast-rewind the starting bar of the selected lesson song.

Press the PLAY/STOP button.

A one bar count-in will be heard before the song starts to play from the specified bar number.

EFFECTS



Rewind one bar

REVERB



Advance one bar

4 Repeating sections of a lesson song

This page will explain how to repeat (loop) specific sections of the selected lesson song between a defined 'A' and 'B' point, allowing difficult passages to be practiced continuously.

1. Specifying the start point (A) of the loop

After selecting a lesson book and song:

Press the PLAY/STOP button.

The LED indicator for the PLAY/STOP button will turn on, and a one bar count-in will be heard before the song starts to play.

```
Burgmueller25-01  
Bar= 5- 1 ♯=126
```

Press the SPLIT button to specify the start point of the loop.

The LED indicator for the SPLIT button will start to flash, indicating that the start point (A) of the loop has been set.

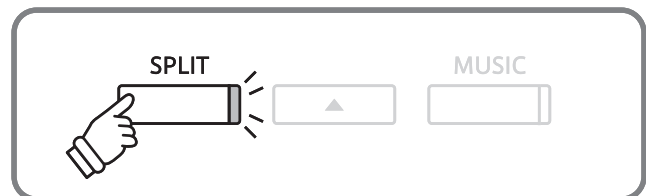

2. Specifying the end point (B) of the loop

Press the SPLIT button again to specify the end point of the loop.

The LED indicator for the SPLIT button will turn on, indicating that the end point of the (B) of the loop has been set.

```
Burgmueller25-01  
Bar= 10- 2 ♯=126
```

The defined 'A-B' section of the lesson song will repeat (loop) continuously, allowing the passage to be practiced.

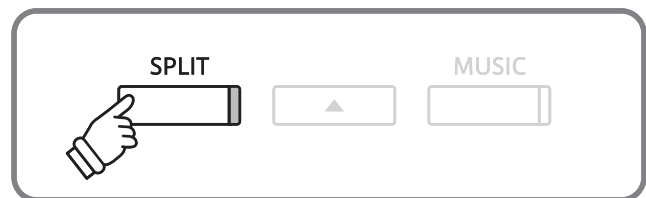

* After defining the loop section, press the ◀ or ▶ buttons to adjust the left/right-hand part volume balance.

3. Cancelling the 'A-B' loop

Press the SPLIT button once again to cancel the 'A-B' loop.

The LED indicator for the SPLIT button will turn off and the lesson song will resume normal playback.

* The loop section can also be specified while the lesson song is paused by pressing the EFFECTS and REVERB buttons to select the bar. The last bar cannot precede the first bar.

5 Recording a lesson song practice

This page will explain how to record the left or right-hand parts of the selected lesson song, then play back the performance for self-evaluation.

1. Starting the lesson song recording

After selecting a lesson book and song:

Press the REC button.

The LED indicators for the REC and PLAY/STOP buttons will turn on to indicate that recording mode is in use.

A one bar count-in will be heard before the lesson song starts to play and record.

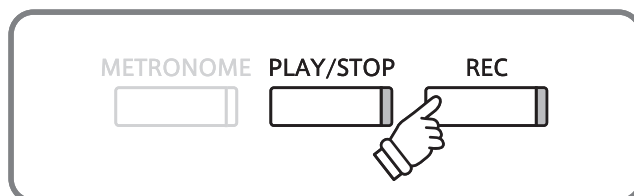

* Press the REVERB or EFFECTS buttons to select the desired start bar before recording.

* Press the ◀ or ▶ buttons to adjust the left/right-hand part volume.

2. Stopping the lesson song recording

Press the PLAY/STOP button.

The LED indicators for the REC and PLAY/STOP buttons will turn off, and the lesson song recording and playback will stop.

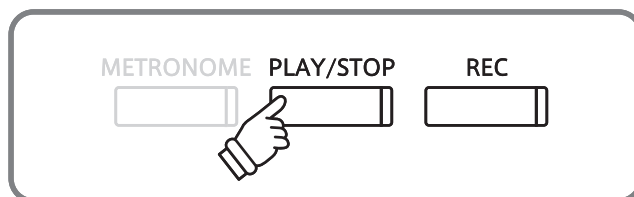

3. Playing back the recorded lesson song

Press the PLAY/STOP button again.

The LED indicator for the PLAY/STOP button will turn on, and a one bar count-in will be heard before the recorded lesson song starts to play.

```
Burgmuller25-01
Bar= 4- 1 ♯=126
```

Press the PLAY/STOP button.

The LED indicator for the PLAY/STOP button will turn off, and the recorded lesson song will stop playing.

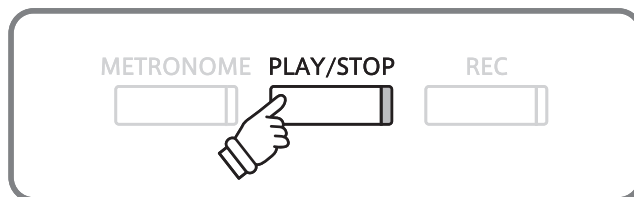

* Press the REVERB or EFFECTS buttons to select the desired start bar before recording.

* Press the ◀ or ▶ buttons to adjust the left/right-hand part volume.

* The 'A-B' loop function cannot be used when recording a lesson song practice.

* Press the REC and PLAY/STOP buttons simultaneously to erase the recorded lesson song practice. The recorded practice will be erased automatically when a different lesson song is selected.

6 Finger Exercises

The lesson function also includes a selection of finger exercises for practicing major and minor scales, arpeggios, chords, cadences, and Hanon exercises, with notated scores provided in the separate 'Finger Exercises' book.

The CS6 digital piano can also evaluate one's practice, analysing note accuracy, timing evenness, and note volume consistency, before displaying results for each category. Using this function, players can objectively review their performances, and concentrate on improving a particular area of their technique.

1. Selecting and recording a Hanon finger exercise

While Lesson mode is selected:

Select the Hanon lesson book, then select a song number.

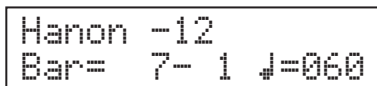

Press the REC button.

The LED indicators for the REC and PLAY/STOP buttons will turn on to indicate that recording mode is in use.

A one bar count-in will be heard before the finger exercise starts to play and record.

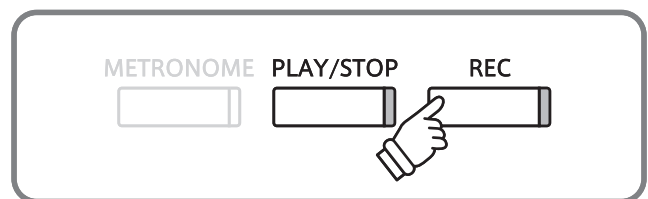

* Press the REVERB or EFFECTS buttons to select the desired start bar before recording.

* Press the ◀ or ▶ buttons to adjust the left/right-hand part volume.

2. Evaluating the recorded finger exercise

Press the PLAY/STOP button

The LED indicators for the REC and PLAY/STOP buttons will turn off, and the finger exercise recording and playback will stop.

The recorded practice will be evaluated for note accuracy, timing evenness, and volume consistency, with the results shown alternately in the LCD display.

* Press the REC and PLAY/STOP buttons simultaneously to erase the recorded finger exercise practice. The recorded practice will be erased automatically when a different lesson song is selected.

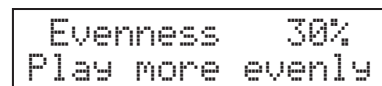
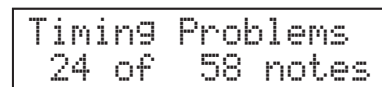
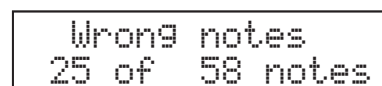

3. Listening to the recorded finger exercise

Press the PLAY/STOP button again.

The LED indicator for the PLAY/STOP button will turn on, and a one bar count-in will be heard before the recorded finger exercise starts to play.

Press the PLAY/STOP button once again.

The LED indicator for the PLAY/STOP button will turn off, and the recorded finger exercise song will stop playing.

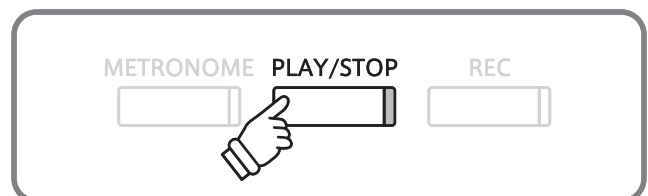

* Press the ◀, ▶, or FUNCTION buttons to cycle through the evaluation results. The recorded finger exercise can be replayed even after cancelling the evaluation result screen.

Concert Magic

The Concert Magic function allows complete beginners to enjoy playing the piano by simply selecting one of the 176 pre-programmed songs, then tapping the keyboard with a steady rhythm and tempo. For a complete listing of available Concert Magic songs, please refer to the separate 'Internal Song Lists' booklet.

1 Performing a Concert Magic song

The 176 Concert Magic songs are divided into banks 'A' and 'B', with each bank containing 88 songs.

1. Entering Concert Magic mode

Press the MUSIC button, then press the ▲ or ▼ buttons until Concert Magic is shown in the LCD Display.

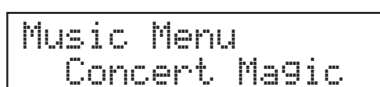

Press the FUNCTION button to enter Concert Magic mode.

The bank, number, and name of the selected Concert Magic song will be shown in the LCD display.

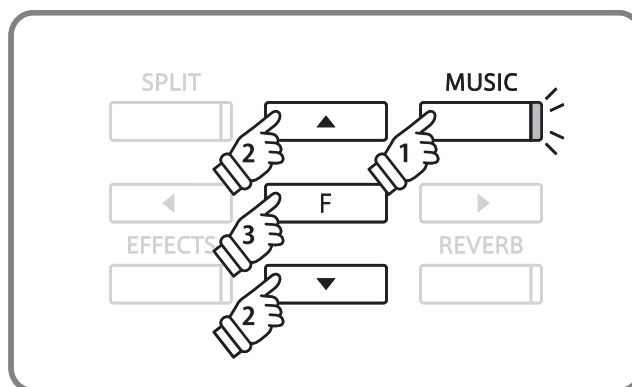

2. Selecting a Concert Magic song

While Concert Magic mode is selected:

Press and hold the MUSIC button, then press the key to which the desired Concert Magic song (bank 'A') is assigned.

A Concert Magic song from bank 'A' will be selected, with the song number and name shown in the LCD display.

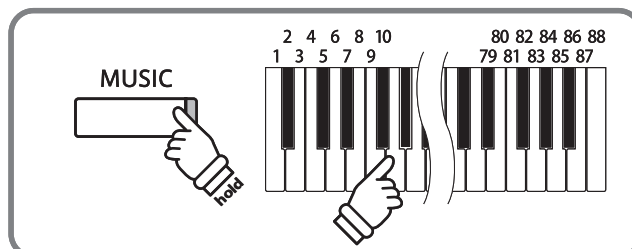
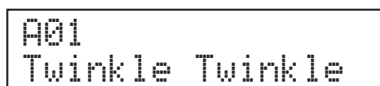

* To select a song from bank 'B', press the same key again. Repeatedly pressing the same key alternates between banks 'A' and 'B'.

3. Performing a Concert Magic song

Press a key on the keyboard.

The song will advance with every key that is pressed. Pressing the keys gently will produce a soft sound, while pressing heavily will produce a loud sound.

As the song advances, the ● symbols shown in the LCD will be replaced by + symbols. This is called the Note Navigator.

* Press the SOUND SELECT buttons to select the desired sound to be used for the Concert Magic song.



* Press the ◀ or ▶ buttons to adjust the left/right-hand part volume.

4. Exiting Concert Magic mode

Press the MUSIC button to exit Concert Magic mode.

2 Concert Magic demo mode

This function allows all of the Concert Magic songs to be played back randomly or in designated categories.

■ Random playback

Enter Concert Magic mode and select the desired song.

Press the PLAY/STOP button.

All 176 Concert Magic songs will be played in a random order until the PLAY/STOP button is pressed.

* Press and hold the METRONOME button, then press the ◀ or ▶ buttons to increase or decrease the tempo of the song.

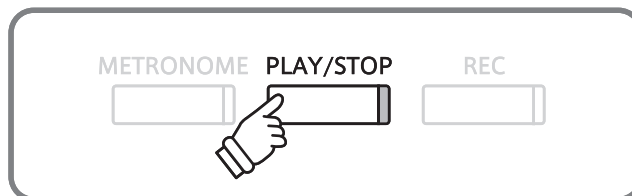

■ Category playback

Enter Concert Magic mode and select the desired song.

Press and hold the MUSIC button, then press the PLAY/STOP button.

Songs in the same category as the selected song, will be played in sequential order until the PLAY/STOP button is pressed.

For example, if the song 'Row, Row, Row Your Boat' is selected, all other songs in the 'Children's Songs' category will be played.

* Press and hold the METRONOME button, then press the ◀ or ▶ buttons to increase or decrease the tempo of the song.

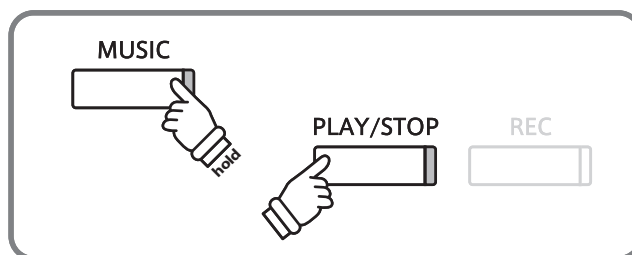

3 Concert Magic song arrangement types

Concert Magic songs are divided into three different arrangement types, each requiring a different level of skill to be performed correctly.

Easy Beat

These are the easiest songs to play. To perform them, simply tap out a constant steady beat on any key on the keyboard.

Look at the following example for 'Für Elise'. The Note Navigator indicates that a constant, steady rhythm should be maintained throughout the song. This is the distinguishing characteristic of an Easy Beat song.

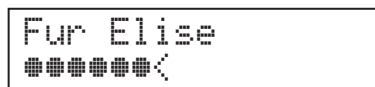

Key on X X X X X X X X X X X X X X X X X X X X

The image shows a musical score for 'Für Elise' in 3/8 time. Above the staff, there are two rows of 'X' marks representing a steady rhythm: 'X X X X X X X X' and 'X X X X X X'. The melody is written in the treble clef, and the bass line is in the bass clef. The rhythm is consistent throughout the piece.

Melody Play

These songs are also relatively easy to play, especially if they are familiar to the player. To perform them, tap out the rhythm of the melody on any key of the keyboard. Singing along as the rhythm is tapped can be helpful.

Play 'Twinkle, Twinkle, Little Star', for example. Follow the melody's rhythm as shown below.

Key on X X X X X X X X X X X X X X

The image shows a musical score for 'Twinkle, Twinkle, Little Star' in C major. Above the staff, there are two rows of 'X' marks representing the melody's rhythm: 'X X X X' and 'X X X'. The melody is written in the treble clef, and the bass line is in the bass clef. The rhythm is consistent throughout the piece.

When performing fast Concert Magic songs, it is sometimes easier to tap two different keys with two alternating fingers in order to play at a greater speed.

■ Skillful

These songs range in difficulty from moderately difficult to difficult. To perform them, tap out the rhythm of both the melody and the accompaniment notes on any key of the keyboard. The Note Navigator will be very helpful with the Skillful type songs.

The song 'Waltz of the Flowers' is shown below.

Waltz of Flowers

● ● ● ● <

Key on X X X X X X X X X X X X X

It may take a little practice to perform the Concert Magic songs proficiently. A good way to learn is to listen to these pieces first, and then try to tap out the rhythms that are heard.

* The 'Internal Song Lists' booklet indicates the arrangement type next to each song title as 'EB' for Easy Beat, 'MP' for Melody Play and 'SK' for Skillful.

4 Steady Beat mode

Steady Beat mode allows all Concert Magic songs to be played by simply tapping any key with a constant steady beat, regardless of the song arrangement type.

■ Selecting Steady Beat mode

While Concert Magic mode is selected:

Press the FUNCTION button.

The current Concert Magic mode (NORMAL) will be shown on the second line of the LCD display.

Press the FUNCTION button again.

The Concert Magic mode will change to STEADY BEAT.

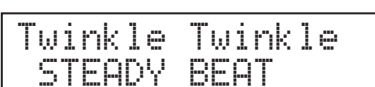
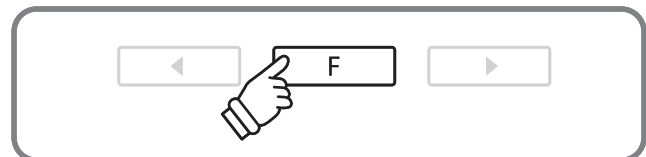

All Concert Magic songs can now be played by simply tapping any key with a constant steady beat.

Song Recorder (Internal memory)

The CS6 digital piano allows up to 10 different songs to be recorded, stored in internal memory, and played back at the touch of a button. Each song consists of two separate tracks - referred to as 'parts' - that can be recorded and played back independently. This allows the left-hand part of a song to be recorded first on one track, and the right-hand part to be recorded later on the other track.

1 Recording a song

1. Entering song recorder mode

Press the REC button.

The LED indicator for the REC button will start to flash, and the Record Internal screen will appear with the currently selected song and part number shown in the LCD display.

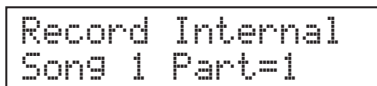

Record Internal
Song 1 Part=1

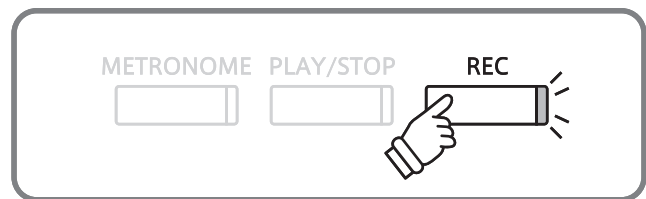

* If a USB memory device is connected, press ▼ button to select Record Internal, then press the FUNCTION button.

2. Selecting the song/part to be recorded

Press the ▲ or ▼ buttons to select the song to be recorded, then press the ◀ or ▶ buttons to select the part to be recorded.

If a part has been recorded, a * symbol will be shown.



Record Internal
Song 1 Part=1*

Part has been recorded

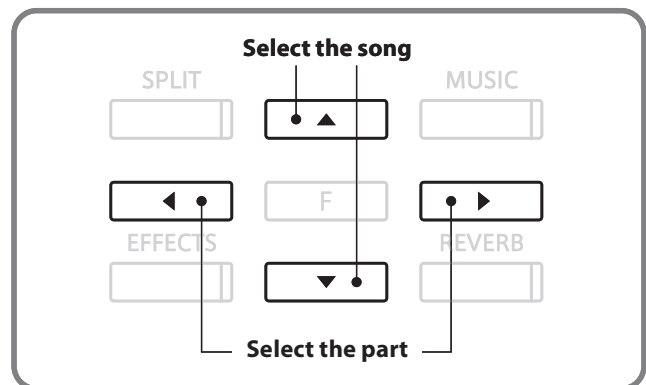

* Re-recording a part will automatically erase all previously recorded performance information for that part.



When recording part 1 and part 2 separately, select the song and part number carefully in order to prevent accidentally overwriting a previously recorded part.

3. Starting the song recorder

Press a key on the keyboard.

The LED indicators for the REC and PLAY/STOP buttons will turn on, and recording will start.

*Recording can also be started by pressing the PLAY/STOP button, allowing a rest period or empty bar to be inserted at the beginning of the song.



4. Stopping the song recorder

Press the PLAY/STOP button.

The LED indicators for the PLAY/STOP and REC buttons will turn off, the recorder will stop, and the part/song will be stored in internal memory.

After a few seconds, the Play Internal screen will be shown in the LCD display, indicating that the song is ready for playback.

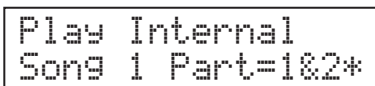

To play back the recorded song, please refer to the 'Playing back a song' instructions on page 38.

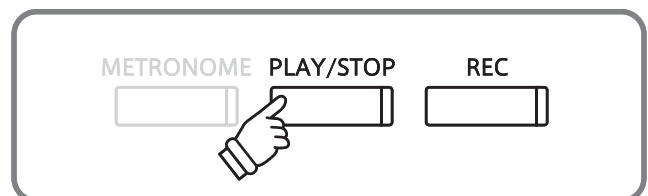

* The maximum recording capacity is approximately 90,000 notes, with button and pedal presses also counted as one note.

* If the maximum recording capacity is reached during recording, the recorder will stop automatically.

* Recorder songs will remain in memory after the power is turned off.

■ Changing panel settings while recording

Panel operations stored during recording
Changes made to the sound type. (SOUND SELECT buttons etc.)
Switching between dual/split modes.

Panel operations NOT stored during recording
Changes made to the reverb settings.
Changes made to the effects settings.
Changes made to the tempo.
Changes made to the volume balance in dual/split mode.
Changes made to transpose, tuning, touch, etc.

* Prepare the desired effect, reverb, tempo settings etc. before recording a new performance.

2 Playing back a song

This function is used to playback recorder songs stored in internal memory. To playback a song/part immediately after recording, start this process from step 2.

1. Entering song play mode

Press the PLAY/STOP button.

The LED indicator for the PLAY/STOP button will turn on, and the Play Internal screen will appear with the currently selected song and part number shown in the LCD display.

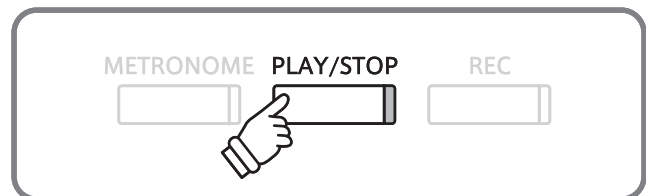

```
Play Internal
Song 1 Part=1&2*
```

* If a USB memory device is connected, press the ▲ or ▼ buttons to select the [Play Internal] option, then press the FUNCTION button.

2. Selecting a song/part(s) to be played back

Press the ▲ or ▼ buttons to select the song, then press the ◀ or ▶ buttons to select the part(s) to be played back.

If a part has been recorded, a * symbol will be shown.

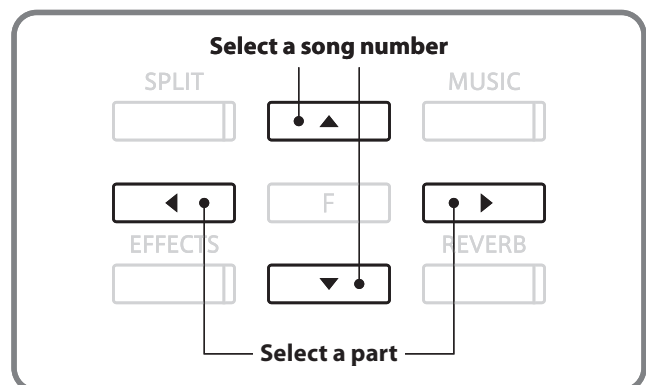

```
Play Internal
Song 1 Part=1&2*
Part has been recorded
```

3. Starting song playback

Press the PLAY/STOP button.

The selected song/part(s) will start to play.

Press the PLAY/STOP button again.

The song will stop, and return to the Play Internal screen.

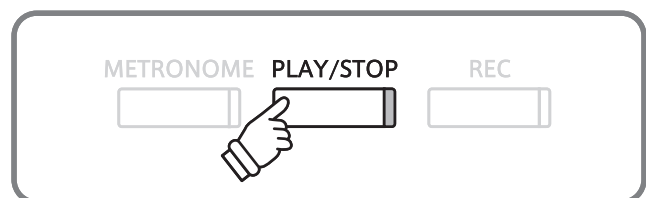

4. Exiting song play mode

Press a SOUND SELECT button to exit Play mode.

The instrument will return to normal operation, and the name of the selected sound will be shown in the LCD display.

3 Erasing a part/song

This function is used to erase recorder parts/songs that have been recorded incorrectly, or are simply no longer required.

1. Entering erase mode

Press the PLAY/STOP and REC buttons simultaneously.

The LED indicators for the PLAY/STOP and REC buttons will start to flash, and the Erase screen will appear with the currently selected song and part number shown in the LCD display.



2. Selecting a song and part to be erased

Press the ▲ or ▼ buttons to select the song, then press the ◀ or ▶ buttons to select the part(s) to be erased.

If a part has been recorded, a * symbol will be shown.

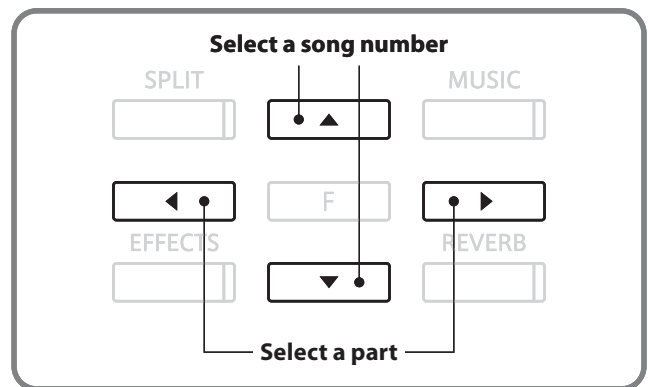
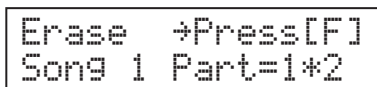

3. Erasing a song

Press the FUNCTION button.

A confirmation message will be shown in the LCD display, prompting to confirm or cancel the erase operation.

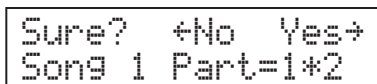

Press the ▶ button to confirm the erase operation and return to the Play Internal screen

Press the ◀ button to cancel the erase operation.

* If cancelled, press the PLAY/STOP button to return to the Play Internal screen, or REC button to return to the Record Internal screen.

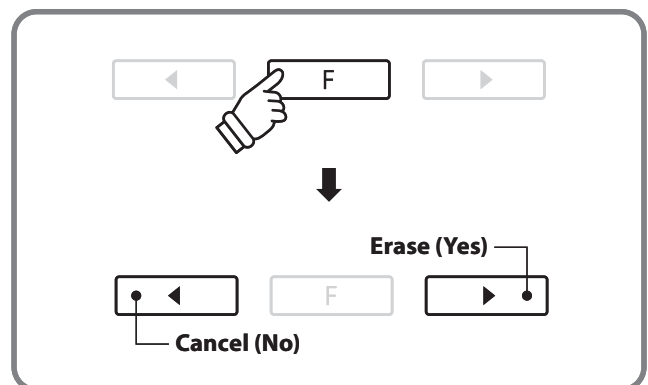

Erasing all recorder songs from memory

Press and hold the PLAY/STOP and REC buttons, then turn the instrument's power off/on.

All recorder songs stored in memory will be erased.

Audio Record/Playback (USB memory)

The CS6 digital piano is also capable of recording performances as digital audio - saving the data to a USB memory device in either MP3 or WAV format. This useful function allows professional quality recordings to be produced directly on the instrument - without the need for additional sound equipment - then emailed to friends and family, played back through an iPod, or edited and remixed further using an audio workstation.

■ Audio Recorder format specifications

Audio format	Specifications	Bitrate
MP3	44.1 kHz, 16 bit, Stereo	192 kbit/s (fixed)
WAV	44.1 kHz, 16 bit, Stereo	1,411 kbit/s (uncompressed)

MPEG Layer-3 audio coding technology licensed from Fraunhofer IIS and Thomson.
MP3 codec is Copyright (c) 1995-2007, SPIRIT

1 Recording an audio file

1. Entering audio recorder mode

Connect a USB memory device to the USB port.

Press the REC button.

The LED indicator for the REC button will start to flash, and the Record Audio screen will be shown in the LCD display.

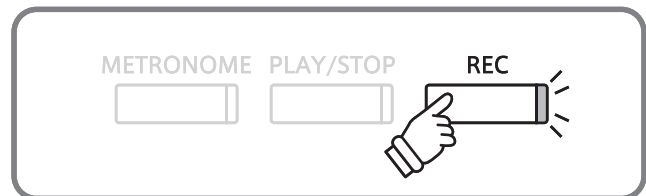

2. Selecting the audio recorder file format

Press the ▲ or ▼ buttons to select the desired audio recorder file format.

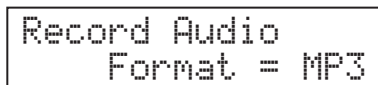

* MP3 audio files require less storage space than WAV audio files.

* A 1 GB USB memory device can store over 12 hours of MP3 audio data.

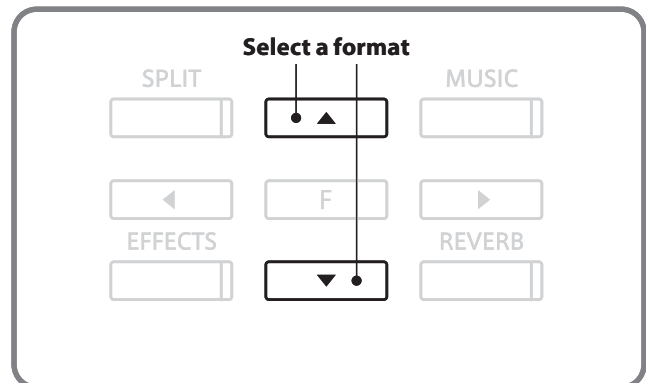

3. Starting the audio recorder

Press a key on the keyboard.

The LED indicators for the REC and PLAY/STOP buttons will turn on, and recording will start.

* Recording can also be started by pressing the PLAY/STOP button, allowing a rest period to be inserted at the beginning of the audio file.



4. Stopping the audio recorder, saving to USB

Press the PLAY/STOP button.

The LED indicators for the PLAY/STOP and REC buttons will turn off, and recording will stop.

A confirmation message will be shown in the LCD display, prompting to confirm the save operation.

```
Save to USB?
←No          Yes→
```

Press the ◀ or ▶ buttons to cancel or confirm the operation.

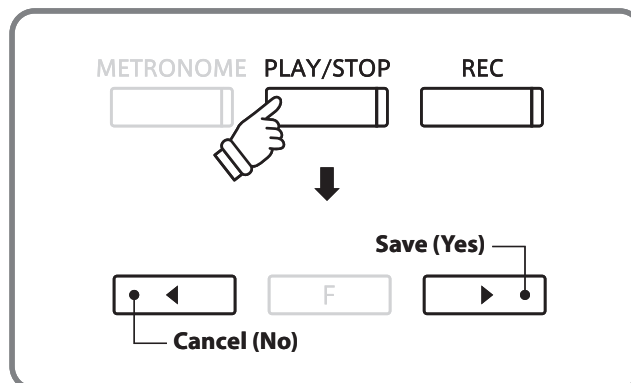

5. Naming the recorded audio file, confirming save

After confirming the save operation:

Press the ▲ or ▼ buttons to cycle through the alphanumeric characters, and the ◀ or ▶ buttons to move the cursor.

```
Name:   Press[F]
MP3 Song 01
```

Press the FUNCTION button.

A final confirmation message will be shown in the LCD display, prompting to confirm the save operation.

```
Are you sure?
←No          Yes→
```

Press the ◀ or ▶ buttons to cancel or confirm the operation.

The recorded audio file will be saved with the specified name.

After a few seconds, the Play Audio screen will be shown in the LCD display, indicating that the audio is ready for playback.

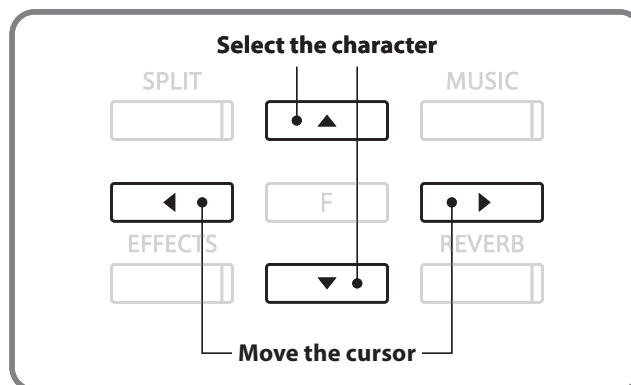

* 'MP3 Song 01' or 'WAV Song 01' will be used as the default name for the recorded audio files, with the number increasing automatically.

* New files are limited to a maximum name length of 12 characters.

* The saved audio file will be stored in the root folder of the USB memory device. It is not possible to store the file in a different folder.

* The audio recorder will only record sounds produced by the instrument. Devices connected via the LINE IN jacks will not be recorded.

■ Overwriting the file

If the specified name already exists:

A confirmation message will be shown in the LCD display, prompting to confirm or cancel the overwrite operation.

```
Overwrite file?
←No          Yes→
```

Press the ◀ or ▶ buttons to cancel or confirm the operation.

* If cancelled, the audio recorder will return to the saving screen (step 4).

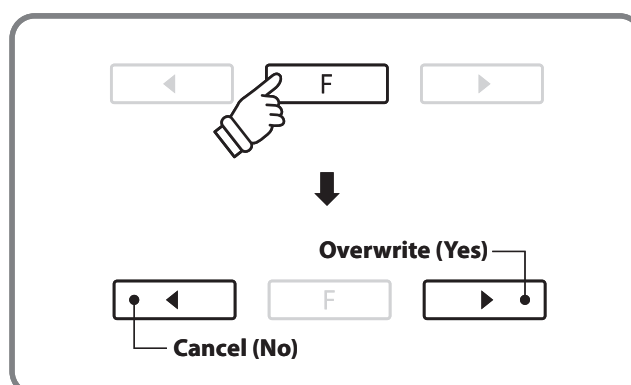

Audio Record/Playback (USB memory)

The CS6 digital piano is also capable of playing MP3 and WAV audio files stored on a USB memory device directly through the instrument's speaker system. This function is particularly useful when attempting to learn the chords or melody to a new piece, or to simply play along with one's favorite song.

■ Audio Player supported format specifications

Audio format	Specifications	Bitrate
MP3	32 kHz/44.1 kHz/48 kHz, Mono/Stereo	8-320 kbit/s (fixed & variable)
WAV	32 kHz/44.1 kHz/48 kHz, Mono/Stereo, 8 bit/16 bit	-

MPEG Layer-3 audio coding technology licensed from Fraunhofer IIS and Thomson.

MP3 codec is Copyright (c) 1995-2007, SPIRIT

■ Preparing the USB memory device

First, prepare a selection of MP3 or WAV audio files, copying the data to a USB memory device.

* USB devices should be formatted to use the 'FAT' or 'FAT32' filesystems.

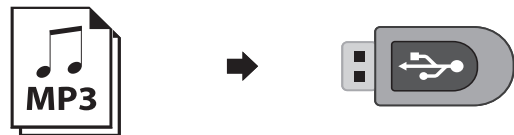

2 Playing an audio file

1. Entering audio playback mode

Connect a USB memory device to the USB port.

Press the PLAY/STOP button.

The contents of the root folder of the USB memory device will be shown in the LCD display.

A ▶ symbol is used to indicate the selected file/folder.



Selection cursor

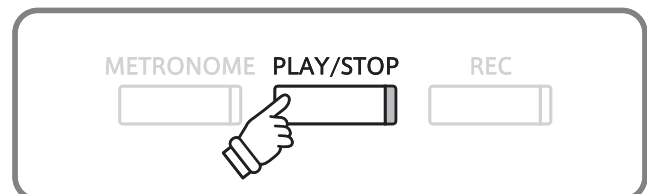

* The LCD display is capable of showing filenames with a maximum length of 11 characters (+3 character suffix). Filenames longer than 11 characters will be truncated automatically.

2. Selecting an audio file

Press the ▲ or ▼ buttons to move the selection cursor.

If a folder is selected, press the FUNCTION button to list the contents of the folder.

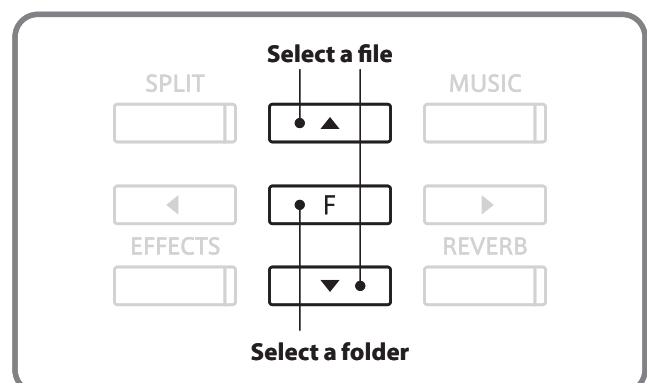

■ File/folder listing screen

The topmost two entries shown in [] symbols are used to select a recorder song stored in internal memory ('Play Internal' option), or to return to the previous folder ('Parent Dir' option).

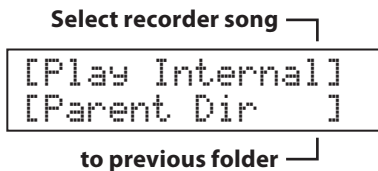

The < > symbols are used to indicate a folder.



An example of a typical file/folder listing screen is shown below. For the purpose of illustration, the visible height of the screen has been extended.

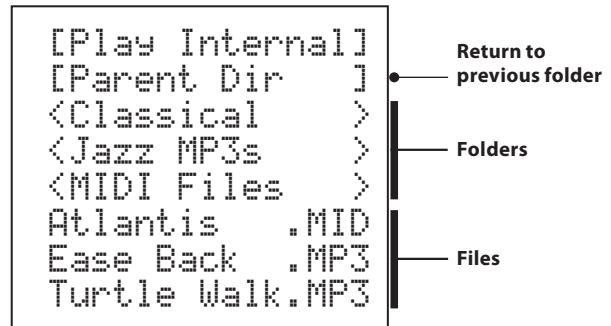

3. Starting audio file playback

Press the PLAY/STOP button.

The selected audio file will start to play, with the filename, volume, and playing time shown in the LCD display.

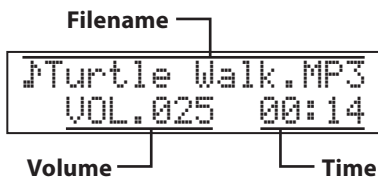

Press the PLAY/STOP button again.

The audio file will stop, and return to the file selection screen.

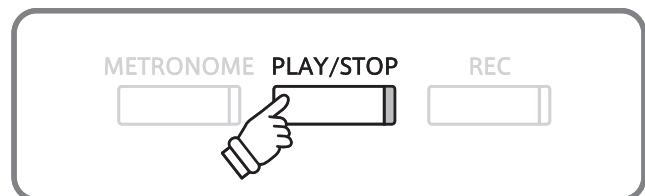

* If the selected audio file contains embedded metadata (e.g. ID3 tags) such as artist name and song title, this information will be shown beside the filename, on the top line of the LCD display.

* To activate the 'Chain Play' mode, press and hold the PLAY/STOP button when selecting the file. The contents of the current folder will be played in alphabetical order after the initial file has finished playing.

■ Controlling audio file playback

While the audio file is playing:

Press the ▲ or ▼ buttons to increase or decrease the playback volume of the audio file.

* There may be a noticeable difference in volume between audio file playback and the CS6 keyboard sound. When playing back MP3/WAV audio data, please adjust the volume of the audio file as desired.

Press the ◀ or ▶ buttons to rewind or advance the playing position of the audio file.

Press the FUNCTION button to show the Key Transpose screen (page 48), allowing the keyboard pitch to be raised/lowered.

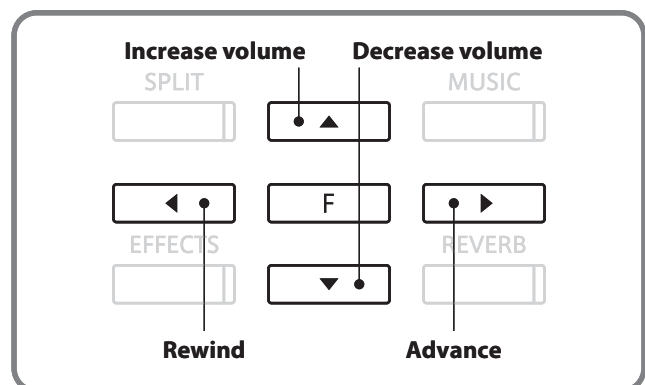

4. Exiting audio playback mode

Press a SOUND SELECT button to exit Play mode and return to normal operation.

The CS6 digital piano also supports the playback of Standard MIDI File (SMF) song files stored on a USB memory device, allowing a vast selection of widely accessible music to be heard through the instrument's exquisite Ultra Progressive Harmonic Imaging sound engine.

3 Playing a song file

1. Entering audio playback mode

Connect a USB memory device to the USB port.

Press the PLAY/STOP button.

The LED indicator for the PLAY/STOP button will turn on and the contents of root folder of the USB memory device will be shown in the LCD display.

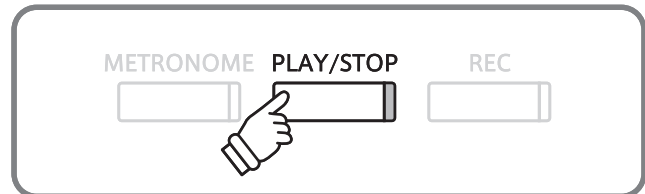

2. Selecting a song file

Press the ▲ or ▼ buttons to move the selection cursor.

Select a SMF song file (.MID filename extension).

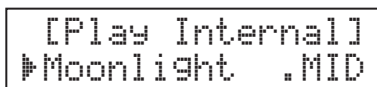

If a folder is selected, press the FUNCTION button to list the contents of the folder.

* Select the [Play Internal] function to select a recorder song stored in internal memory.

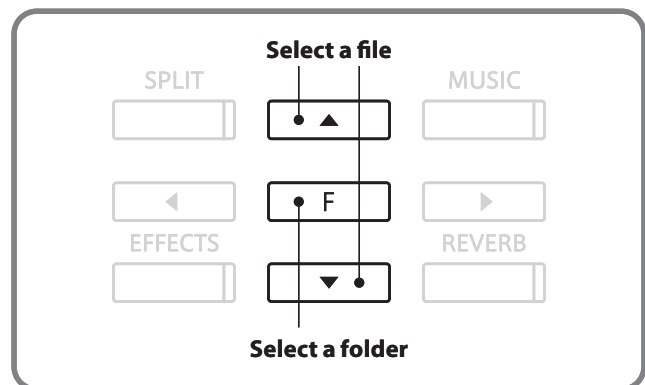

3. Controlling song file playback

Press the PLAY/STOP button.

The selected song file will start to play, with the filename, volume, and playing time shown in the LCD display.

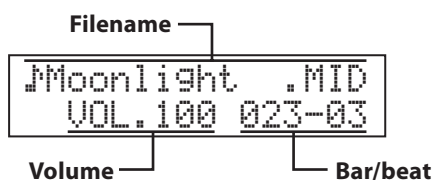

Press the ▲ or ▼ buttons to increase or decrease the playback volume of the song file.

Press the ◀ or ▶ buttons to rewind or advance the playing position of the song file.

* Press and hold the METRONOME button, then press the ◀ or ▶ buttons to increase or decrease the tempo of the song file.

Press the PLAY/STOP button again.

The song file will stop, and return to the file selection screen.

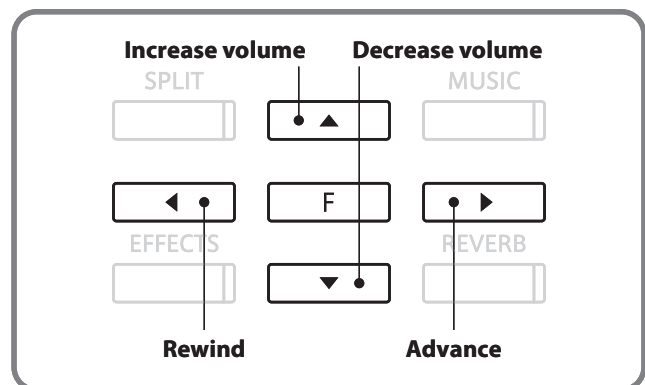

* The CS6 digital piano does not contain the full General MIDI/GM2 sound bank selection. Consequently, some SMF song files may not be reproduced entirely accurately when played through the instrument.

* To activate the 'Chain Play' mode, press and hold the PLAY/STOP button when selecting the file. The contents of the current folder will be played in alphabetical order after the initial file has finished playing.

4 Converting a song to an audio file

The CS6 digital piano allows recorder songs stored in internal memory to be played back and saved (converted) as an audio file to a USB device in either MP3 or WAV format.

1. Selecting a song

After recording a song to internal memory:

Connect a USB memory device to the USB port.

Press the PLAY/STOP button, select the [Play Internal] option, then press the FUNCTION button.

The Play Internal screen will appear, with the currently selected song and part number shown in the LCD display.

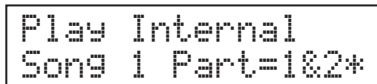

Press the ▲ or ▼ buttons to select the song, then press the ◀ or ▶ buttons to select the part(s) to played and converted.

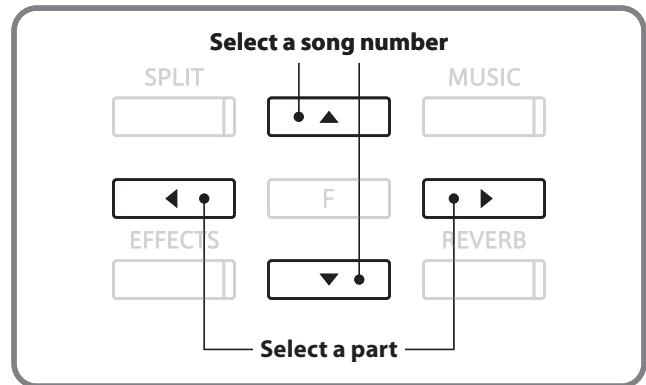

2. Selecting the Convert to Audio function

Press the FUNCTION button.

The Convert to Audio screen will be shown in the LCD display.

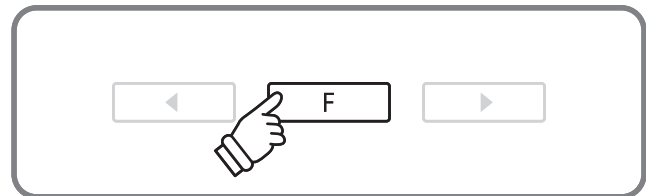
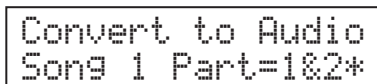

3. Selecting the Convert to Audio file format

Press the REC button, then press the ▲ or ▼ buttons to select the desired file format for the converted song.

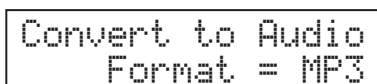

Press the PLAY/STOP button or a key on the keyboard.

The LED indicators for the REC and PLAY/STOP buttons will turn on, the selected song will play, and the convert to audio process will start.

* Notes played on the keyboard will also be recorded to the audio file.

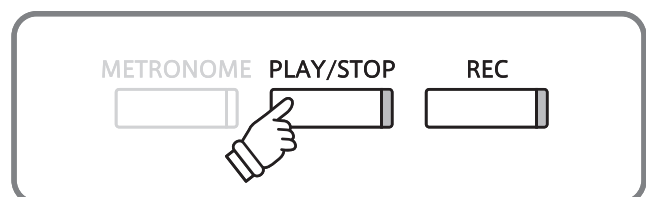

4. Naming and saving the audio file

Please follow the 'Recording an audio file' instructions on page 40 from step 4.

Functions menus

The Functions menus contain various options for adjusting the control operation and tonal characteristic of the CS6 digital piano. There are six different menus, each consisting of several different settings.

■ Entering the Functions menus

Press the FUNCTION button on the normal operation screen.

The first functions menu (Basic Settings) will be shown in the LCD display.

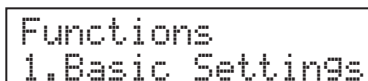

Functions
1. Basic Settings

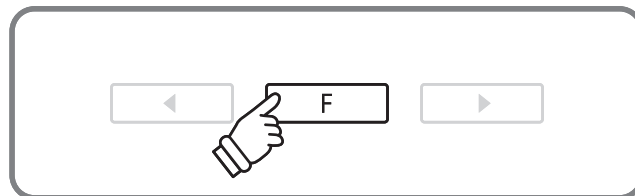

Press the ▲ or ▼ buttons to cycle through the different menus.

Press the FUNCTION button again to enter the selected menu.

■ Functions menus and settings

1. Basic Settings

Key Transpose, Song Transpose, Tone Control, Speaker Volume, Phones Volume, Tuning, Damper Hold, Four Hands, User Memory, Factory Reset

2. Virtual Technician

Touch, Voicing, Damper Resonance, String Resonance, Key-off Effect, Stretch Tuning, Temperament, Key of Temperament

3. Key Settings

Lower Octave Shift, Lower Pedal On/Off, Layer Octave Shift, Layer Dynamics

4. MIDI Settings

MIDI Channel, Send Program Change No., Local Control, Transmit PGM Change, Multi Timbre, Channel Mute

5. USB Menu

USB Load, USB Save, USB Rename, USB Delete, USB Format

6. Power Setting

Auto Power Off

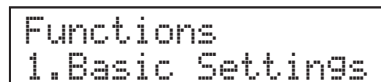

Functions
1. Basic Settings



Functions
2. Virtual Tech.

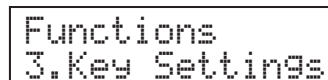

Functions
3. Key Settings



Functions
4. MIDI Settings



Functions
5. USB Menu

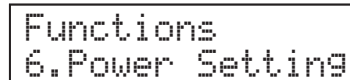

Functions
6. Power Setting

Basic Settings

The Basic settings menu contains settings to adjust the pitch, tuning, and general sound of the instrument. This menu also allows favourite panel settings to be stored, or reset back to the original factory configuration.

Basic Settings

Page no.	Setting name	Explanation	Default setting
1	Key Transpose	Raise or lower the pitch of the keyboard in semi-tone steps.	0 C
2	Song Transpose	Raise or lower the pitch of SMF songs in semi-tone steps.	0
3	Tone Control	Change the EQ settings of the instrument's sound.	off
4	Speaker Volume	Change the maximum volume level of the speaker output.	High
5	Phones Volume	Change the maximum volume level of the headphones output.	Low
6	Tuning	Increase or decrease the pitch of the instrument in 0.5 Hz steps.	440.0
7	Damper Hold	Change the effect of the sustain pedal on organ, string, etc. sounds.	off
8	Four Hands	Enable the 'Four Hands Mode' function.	off
9	User Memory	Store current panel settings as the default (power on) configuration.	-
10	Factory Reset	Reset panel settings back to the original factory configuration.	-

* Default settings will be shown in the first LCD display illustration (i.e. Step 1) for each setting explanation below.

Entering the Basic Settings menu

Press the FUNCTION button to enter the Functions menu.

The Basic Settings menu will be selected automatically.

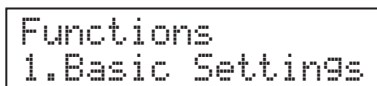

Press the FUNCTION button again to enter the menu.

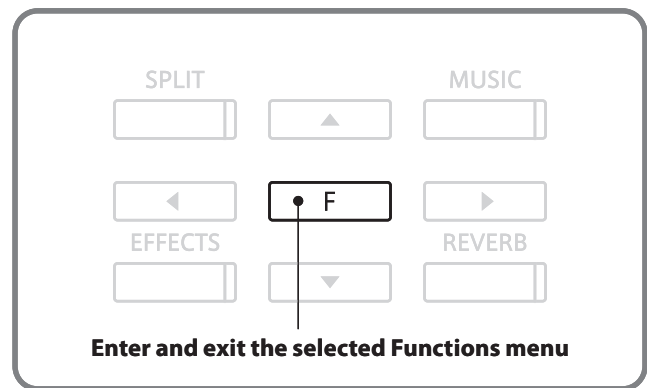

Selecting the desired setting

After entering the Basic Settings menu:

Press the ◀ or ▶ buttons to cycle through the different settings pages.



Settings page number

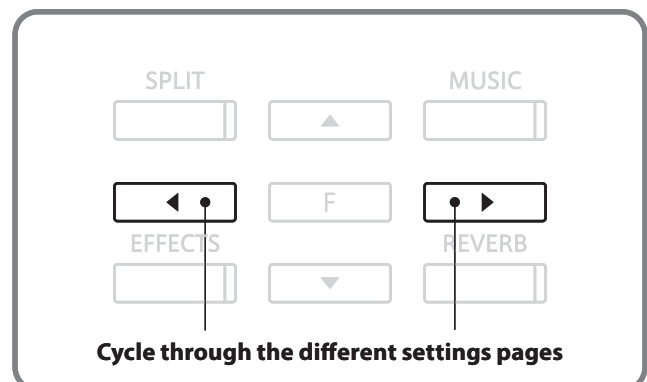

1 Key Transpose

The Key Transpose setting allows the pitch of the CS6 digital piano keyboard to be raised or lowered in semi-tone steps. This is particularly useful when accompanying instruments with different tones, or when a song learned in one key must be played in another key. When transposed, the song can be played in the original key, yet heard in a different key.

1. Selecting the Key Transpose setting

Enter the Basic Settings menu (page 47).

The Key Transpose setting will be selected automatically.

```
1-1 KeyTranspose  
= 0 C
```

2. Adjusting the Key Transpose value

Press the ▲ or ▼ buttons to increase or decrease the value of the Key Transpose setting.

* The keyboard pitch can be raised or lowered by up to 12 semi-tones.

Press a SOUND SELECT button to exit the Key Transpose setting and return to normal operation.

```
1-1 KeyTranspose  
= +4 E
```

2 Song Transpose

The Song Transpose setting allows the pitch of SMF song files stored on a USB memory device to be raised or lowered in semi-tone steps when played back.

1. Selecting the Song Transpose setting

Enter the Basic Settings menu (page 47).

Press the ◀ or ▶ buttons to select the Song Transpose setting.

```
1-2SongTranspose  
= 0
```

2. Adjusting the Song Transpose value

Press the ▲ or ▼ buttons to increase or decrease the value of the Song Transpose setting.

* The song pitch can be raised or lowered by up to 12 semi-tones.

Press a SOUND SELECT button to exit the Song Transpose setting and return to normal operation.

```
1-2SongTranspose  
= +2
```

3 Tone Control

The Tone Control setting allows the overall sound character of the CS6 digital piano to be adjusted to provide the best sound quality within the area that the instrument is located. There are five different preset EQ settings available, with an additional 'User' setting allowing finer control over the different frequency bands.

■ Tone Control types

Tone Control type	Explanation
Off	Tone control adjustment is not performed.
Loudness	Emphasises frequencies to retains the instrument's sound character when playing at low volume levels.
Bass boost	Emphasises low-range frequencies, creating a deeper sound.
Treble boost	Emphasises high-range frequencies, creating a brighter sound.
Mid cut	Reduces mid-range frequencies, creating a clearer sound.
User	Allows the low, mid, and high-range frequency bands to be adjusted separately.

1. Selecting the Tone Control setting

Enter the Basic Settings menu (page 47).

Press the ◀ or ▶ buttons to select the Tone Control setting.

```
1-3 Tone Control
= Off
```

2. Changing the Tone Control type

Press the ▲ or ▼ buttons to cycle through the different tone control types.

Press a SOUND SELECT button to exit the Tone Control setting and return to normal operation.

```
1-3 Tone Control
= Loudness
```

■ Creating a User EQ

When selecting the 'User' tone control type:

Press and hold the FUNCTION button.

After a few seconds the User EQ edit mode will be selected, with the low-range frequency band shown in the LCD display.

Press the ◀ or ▶ buttons to select the frequency band to adjust, then press the ▲ or ▼ buttons to increase or decrease the value.

* Each frequency band can be adjust within the range of -6 to +6.

Press the FUNCTION button to exit User EQ edit mode and return to the Tone Control settings screen.

```
1-3 User   Low
          =  0
```



```
1-3 User   Mid
          =  3
```



```
1-3 User   High
          =  5
```

4 Speaker Volume

The Speaker Volume setting allows the maximum volume level of the instrument's speaker output to be reduced, thus providing finer adjustment control over the master volume. This setting can also serve as a volume limiter, preventing the CS6 digital piano from being played too loudly in the home.

* This setting does not affect the headphones or Line-out volume.

1. Selecting the Speaker Volume setting

Enter the Basic Settings menu (page 47).

Press the ◀ or ▶ buttons to select the Speaker Volume setting.

```
1-4 Speaker Vol.  
= High
```

2. Changing the Speaker Volume setting

Press the ▲ or ▼ buttons to alternate between 'High' and 'Low' Speaker Volume types.

Press a SOUND SELECT button to exit the Speaker Volume setting and return to normal operation.

```
1-4 Speaker Vol.  
= Low
```

5 Phones Volume

The Phones Volume setting allows the maximum volume level of the headphones output to be increased.

The default setting for Phones Volume is 'Low' in order to protect an individual's ears from excessive volume levels. The 'High' setting may be selected when using headphones with a high impedance, or in situations where it is desirable to increase the maximum volume level of the headphones output.

* This setting does not affect the speaker or Line-out volume.

1. Selecting the Phones Volume setting

Enter the Basic Settings menu (page 47).

Press the ◀ or ▶ buttons to select the Phones Volume setting.

```
1-5 Phones Vol.  
= Low
```

2. Changing the Phones Volume setting

Press the ▲ or ▼ buttons to alternate between 'High' and 'Low' Phones Volume types.

Press a SOUND SELECT button to exit the Phones Volume setting and return to normal operation.

```
1-5 Phones Vol.  
= High
```

6 Tuning

The Tuning setting allows the overall pitch of the CS6 digital piano to be raised and lowered in 0.5 Hz steps, and may therefore prove useful when playing with other instruments.

1. Selecting the Tuning setting

Enter the Basic Settings menu (page 47).

Press the ◀ or ▶ buttons to select the Tuning setting.

```
1-6 Tuning
      = 440.0
```

2. Adjusting the Tuning value

Press the ▲ or ▼ buttons to increase or decrease the value of the Tuning setting in 0.5 Hz steps.

* The Tuning value can be adjusted within the range of 427.0 - 453.0 Hz.

Press a SOUND SELECT button to exit the Tuning setting and return to normal operation.

```
1-6 Tuning
      = 437.5
```

7 Damper Hold

The Damper Hold setting is used to determine whether sounds such as organ or strings should be sustained continuously when the sustain (damper) pedal is depressed, or whether these sounds should decay, naturally.

■ Damper Hold settings

Damper Hold setting	Explanation
Off	Organ, string, etc. sounds will gradually decay, even while the sustain pedal is depressed.
On	Organ, string, etc. sounds will be sustained continuously while the sustain pedal is depressed.

1. Selecting the Damper Hold setting

Enter the Basic Settings menu (page 47).

Press the ◀ or ▶ buttons to select the Damper Hold setting.

```
1-7 Damper Hold
      = Off
```

2. Changing the Damper Hold setting

Press the ▲ or ▼ buttons to turn the Damper Hold setting on/off.

Press a SOUND SELECT button to exit the Damper Hold setting and return to normal operation.

```
1-7 Damper Hold
      = On
```

8 Four Hands

The Four Hands setting provides an alternative method to enabling the Four Hands Mode function, and may prove useful in teaching environments or situations where the function should be enabled automatically every time the CS6 digital piano is turned on.

When enabled, all Four Hands Mode control operations are identical to those explained on page 47.

1. Selecting the Four Hands setting

Enter the Basic Settings menu (page 47).

Press the ◀ or ▶ buttons to select the Four Hands setting.



1-8 Four Hands
= Off

2. Changing the Four Hands setting

Press the ▲ or ▼ buttons to turn the Four Hands setting on/off.

* When enabled, the LED indicators for the SPLIT and SOUND SELECT buttons will flash.

Press a SOUND SELECT button to exit the Four Hands setting and return to normal operation.



1-8 Four Hands
= On

9 User Memory

The User Memory function allows preferred panel settings to be stored in the instrument's memory, and automatically recalled as the default settings every time the CS6 digital piano is turned on.

■ User Memory

Settings stored in User Memory

Sound type (including starting sound and primary sound for each category)

Effects/Reverb settings

Basic Settings

Virtual Technician Settings

Key Settings

Metronome tempo, time signature/rhythm, and volume

1. Selecting the User Memory function

Enter the Basic Settings menu (page 47).

Press the ◀ or ▶ buttons to select the User Memory function.

```
1-9 User Memory
Save →Press REC
```

2. Storing current settings to User Memory

Press the REC button to confirm the save operation.

The words 'Save Complete' will be shown in the LCD display.

Press a SOUND SELECT button to exit the User Memory function and return to normal operation.

```
Save Complete.
```

10 Factory Reset

The Factory Reset function clears any settings stored using the User Memory function above, resetting the CS6 digital piano back to its factory default settings.

* This function does not clear or otherwise affect recorder songs stored in internal memory.

1. Selecting the Factory Reset function

Enter the Basic Settings menu (page 47).

Press the ◀ or ▶ buttons to select the Factory Reset function.

```
1-10FactoryReset
Reset→Press REC
```

2. Restoring factory settings

Press the REC button to restore factory settings, and exit the menu.

Virtual Technician

An experienced piano technician is essential to fully realise the potential of a fine acoustic piano. In addition to meticulously tuning each note, the technician also performs numerous regulation and voicing adjustments that allow the instrument to truly sing.

The Virtual Technician settings of the CS6 digital piano simulate these refinements digitally, allowing performers to shape various aspects of the instrument's character to suit their personal preferences.

Virtual Technician

Page no.	Setting name	Explanation	Default setting
1	Touch	Adjust the touch sensitivity of the keyboard.	Normal
2	Voicing	Adjust the tonal character of the instrument.	Normal
3	Damper Resonance	Adjust the resonance that is heard when depressing the damper pedal.	5
4	String Resonance	Adjust the resonance that is heard when notes are held.	5
5	Key-off Effect	Adjust the volume of the sound that is heard when keys are released.	5
6	Stretch Tuning	Adjust the level of stretch tuning for equal temperaments.	Normal
7	Temperament	Adjust the tuning system to suit Renaissance and Baroque periods etc.	Equal Temp.
8	Key of Temperament	Adjust the key of the selected tuning system.	C

* Default settings will be shown in the first LCD display illustration (i.e. Step 1) for each setting explanation below.

Entering the Virtual Technician menu

Press the FUNCTION button to enter the Functions menu.

Press the ▲ or ▼ buttons to select the Virtual Technician menu.

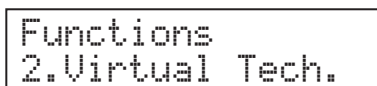

Press the FUNCTION button again to enter the menu.

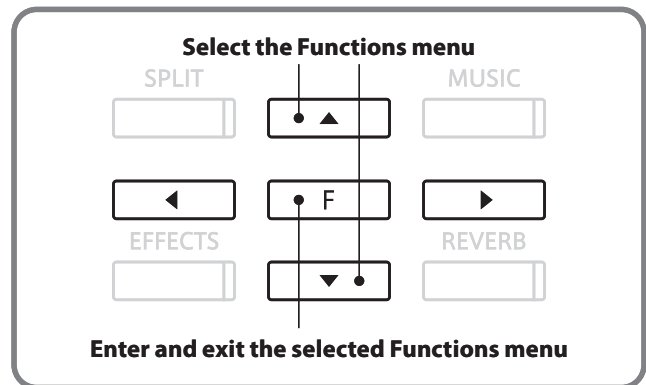

Selecting the desired setting

After entering the Virtual Technician menu:

Press the ◀ or ▶ buttons to cycle through the different settings pages.

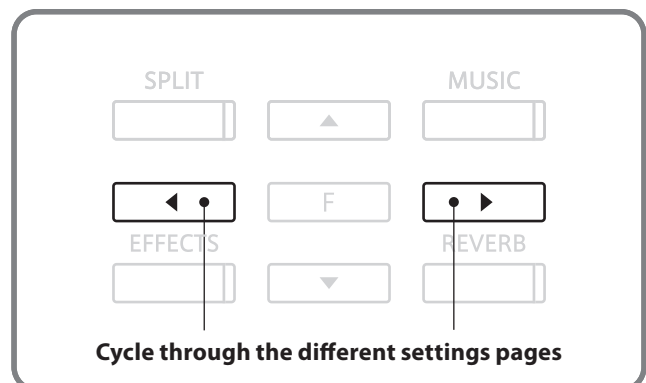

1 Touch

As with an acoustic piano, the CS6 digital piano produces a louder sound when the keys are struck with force, and a softer sound when the keys are played gently. The volume and tonal character change in relation to the strength and speed of playing - on a digital piano this system is referred to as 'touch sensitivity'.

The Touch setting allows the touch sensitivity of the keyboard to be conveniently adjusted. There are six different preset touch curve settings available, with two additional 'User' settings allowing performers to customise the instrument's responsiveness to suit their playing style.

■ Touch type

Touch type	Description
Light +	Requires less striking force to achieve a forte note. For players with a very delicate touch.
Light	A louder volume is produced even when playing with a soft touch. For those still developing finger strength. This curve is recommended for children and organ players.
Normal	Reproduces the standard touch sensitivity of an acoustic piano.
Heavy	Requires a heavier touch to produce a loud volume. Ideally suited to those with stronger fingers.
Heavy +	Requires considerably more striking force to achieve a loud volume.
Off	A constant volume is produced regardless of how hard the keys are struck. Ideally suited for sounds that have a fixed dynamic range such as organ and harpsichord.
User 1 / 2	A custom touch curve, created to suit an individual's personal playing style.

■ Touch Curve graph

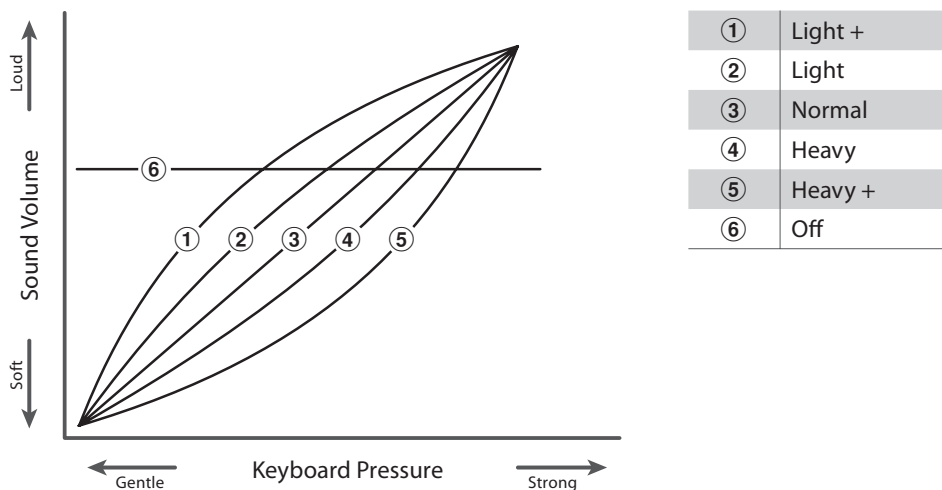

1 Touch (cont.)

1. Selecting the Touch setting

Enter the Virtual Technician menu (page 54).

Press the ◀ or ▶ buttons to select the Touch setting.

```
2-1 Touch
= Normal
```

2. Changing the Touch type

Press the ▲ or ▼ buttons to cycle through the different Touch types.

Press a SOUND SELECT button to exit the Touch setting and return to normal operation.

```
2-1 Touch
= Light
```

■ Creating a User Touch curve

When selecting the 'User1' or 'User2' touch types.

Press the REC button.

Play the piano dynamically from very soft to very loud, allowing the instrument to examine the personal playing technique.

Press the PLAY/STOP button.

The new touch curve will be automatically stored to the selected 'User1' or 'User2' touch type.

* Both 'User1' and 'User2' touch curves will remain stored in memory after the power is turned off.

```
2-1 Touch
=User1→Press REC
```

```
Analyze
Completed
```

2 Voicing

The Voicing setting allows the character of the CS6 digital piano to be set to one of six different types.

■ Voicing type

Voicing type	Description
Normal	The normal tonal character of an acoustic piano throughout the entire dynamic range.
Mellow 1	A softer, more mellow tonal character throughout the entire dynamic range.
Mellow 2	An even softer tonal character than Mellow 1.
Dynamic	A tonal character that changes dramatically from mellow to bright, depending on the strength of key strike.
Bright 1	A bright tonal character throughout the entire dynamic range.
Bright 2	An even brighter tonal character than Bright 1.

1. Selecting the Voicing setting

Enter the Virtual Technician menu (page 54).

The Voicing setting will be selected automatically.

```
2-2 Voicing
    = Normal
```

2. Changing the Voicing type

Press the ▲ or ▼ buttons to cycle through the different tone control types.

Press a SOUND SELECT button to exit the Voicing setting and return to normal operation.

```
2-2 Voicing
    = Mellow1
```

3 Damper Resonance

Depressing the sustain pedal of an acoustic piano raises all dampers, allowing the strings to vibrate freely. When a note or chord is played on the piano with the sustain pedal depressed, not only will the strings of the notes played vibrate, but also the strings of other notes, vibrating in sympathetic resonance.

The CS6 digital piano recreates this phenomenon, with the Damper Resonance setting allowing the volume of this resonance to be adjusted.

■ Damper Resonance

Sounds affected by Damper Resonance				
PIANO 1	Concert Grand	Studio Grand	Mellow Grand	Jazz Grand
	Concert Grand 2	Studio Grand 2	Mellow Grand 2	Jazz Grand 2
PIANO 2	Pop Piano			
	Pop Piano 2			

1. Selecting the Damper Resonance setting

Enter the Virtual Technician menu (page 54).

Press the ◀ or ▶ buttons to select the Damper Resonance setting.

```
2-3 Danfer Reso.
      = 5
```

2. Adjusting the Damper Resonance volume

Press the ▲ or ▼ buttons to increase or decrease the volume of the Damper Resonance setting.

* The damper resonance volume can be adjusted within the range of 1-10.

Press a SOUND SELECT button to exit the Damper Resonance setting and return to normal operation.

```
2-3 Danfer Reso.
      = 6
```

4 String Resonance

String Resonance refers to a phenomenon that exists in acoustic pianos whereby the strings of held notes resonate 'sympathetically' with other notes of the same harmonic series.

The CS6 digital piano recreates this phenomenon, with the String Resonance setting allowing the volume of this resonance to be adjusted.

■ String Resonance

Sounds affected by String Resonance				
PIANO 1	Concert Grand	Studio Grand	Mellow Grand	Jazz Grand
	Concert Grand 2	Studio Grand 2	Mellow Grand 2	Jazz Grand 2
PIANO 2	Pop Piano	Modern Piano		
	Pop Piano 2	Rock Piano		

■ Demonstrating String Resonance

To experience the string resonance phenomenon, gently hold down the 'C' key as shown in the illustration below, then press any of the keys marked with a ● symbol. In addition to the sound of each note played, it should also be possible to hear the strings of the first 'C' key resonating 'sympathetically', thus demonstrating String Resonance.

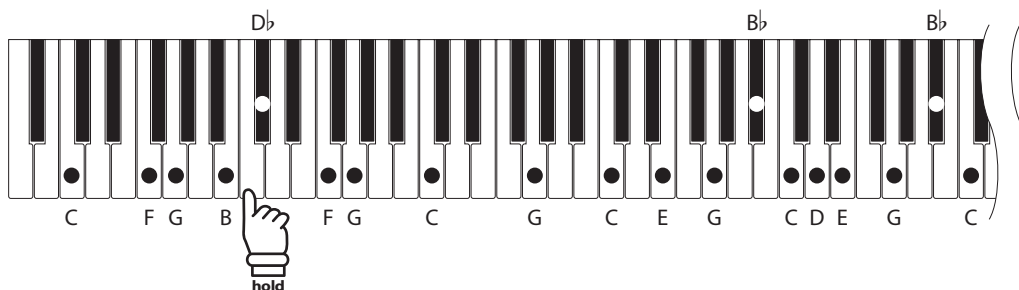

1. Selecting the String Resonance setting

Enter the Virtual Technician menu (page 54).

Press the ◀ or ▶ buttons to select the String Resonance setting.

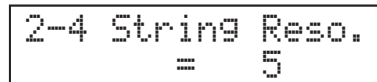

2. Adjusting the String Resonance volume

Press the ▲ or ▼ buttons to increase or decrease the volume of the String Resonance setting.

* The string resonance volume can be adjusted within the range of 1-10.

Press a SOUND SELECT button to exit the String Resonance setting and return to normal operation.



5 Key-off Effect

When playing an acoustic piano - particularly in the bass region of the keyboard - if a key is played with force and released quickly, it is often possible to hear the faint sound of the damper touching the strings immediately before the vibrations are stopped.

The CS6 digital piano recreates this phenomenon, with the Key-off Effect setting allowing the volume of this sound to be adjusted.

1. Selecting the Key-off Effect setting

Enter the Virtual Technician menu (page 54).

Press the ◀ or ▶ buttons to select the Key-off Effect setting.

```
2-5 KeyOffEffect
    = 5
```

2. Adjusting the Key-off Effect volume

Press the ▲ or ▼ buttons to increase or decrease the volume of the Key-off Effect setting.

* The key-off effect volume can be adjusted within the range of 1-10.

Press a SOUND SELECT button to exit the Damper Resonance setting and return to normal operation.

```
2-5 KeyOffEffect
    = 6
```

6 Stretch Tuning

Stretch tuning is a piano-specific tuning method in which the tuning for the lower notes is slightly lower and the tuning for the higher notes is slightly higher than the settings made in the equal temperament.

The Stretch Tuning setting allows the degree of stretch tuning to be adjusted when Equal Temperament (piano) or Equal Temperament is selected.

1. Selecting the Stretch Tuning setting

Enter the Virtual Technician menu (page 54).

Press the ◀ or ▶ buttons to select the Stretch Tuning setting.

```
2-6 StretchTune
    = Normal
```

2. Changing the Stretch Tuning type

Press the ▲ or ▼ buttons to select the desired Stretch Tuning type.

* When the 'Wide' stretch tuning type is selected, tuning adjustments made to the lower and higher notes will be more pronounced.

Press a SOUND SELECT button to exit the Stretch Tuning setting and return to normal operation.

```
2-6 StretchTune
    = Wide
```

7 Temperament

The Temperament setting allows the tuning system used by the CS6 digital piano to be changed from the modern 'Equal Temperament' standard to one of the various musical temperaments popularised during the Renaissance and Baroque periods.

■ Available Temperament types

Temperament type	Description
Equal Temperament (piano) (Equal P.only)	This is the default temperament. When a piano sound is selected, the tuning will be stretched like an acoustic piano (equal temperament). * If any other type of sound is selected, the tuning will be set to equal temperament (flat).
Pure Temperament (major) (Pure Major) Pure Temperament (minor) (Pure Minor)	This temperament, which eliminates dissonances for thirds and fifths, is still popular in choral music because of its perfect harmony. Any key modulation will result in dissonances. * The key of the temperament, and major/minor setting must be correctly matched.
Pythagorean Temperament (Pythagorean)	This temperament, which uses mathematical ratios to eliminate dissonance for fifths, is very limited for use with chords, but produces very characteristic melodic lines.
Meantone Temperament (Meantone)	This temperament, which uses a mean between a major and minor whole tone to eliminate dissonance for thirds, was devised to eliminate the lack of consonances experienced with certain fifths for the Mersenne pure temperament. It produces chords that are more beautiful than those played with equal temperament.
Werckmeister III Temperament (Werkmeister) Kirnberger III Temperament (Kirnberger)	These two temperaments are placed in between Meantone and Pythagorean. For music with few accidentals, this temperament produces the beautiful chords of the mean tone, but as accidentals increase, the temperament produces the characteristic melodies of the Pythagorean temperament. It is used primarily for classical music written in the Baroque era to revive the original characteristics.
Equal Temperament (flat) (Equal Flat)	This is an 'unstretched' equal temperament that divides the scale into twelve equal semi-tones. It produces the same chordal intervals in all twelve keys, and has the advantage of limitless modulation of the key. However the tonality of each key becomes less characteristic and no chord is in pure consonance.
Equal Temperament (Equal Stretch)	This is the most popular piano temperament. The hearing ability of a human is uneven and is not as accurate with high frequency and low frequency as it is with the middle range. This temperament's tuning is stretched to compensate for this so the sound will be heard naturally to the ears. This 'stretched' equal temperament is a practical variation of the 'unstretched' equal temperament which was invented on a mathematical basis.
User Temperament (User)	A custom, user temperament, created by raising or lowering the pitch for each semi-tone.

7 Temperament (cont.)

1. Selecting the Temperament setting

Enter the Virtual Technician menu (page 54).

Press the ◀ or ▶ buttons to select the Temperament setting.

```
2-7 Temperament
= Equal(P.only)
```

2. Changing the Temperament type

Press the ▲ or ▼ buttons to cycle through the different Temperament types.

Press a SOUND SELECT button to exit the Temperament setting and return to normal operation.

```
2-7 Temperament
= Meantone
```

■ Creating a User Temperament

When selecting the 'User' temperament type:

Press and hold the FUNCTION button.

After a few seconds the User Temperament edit mode will be selected, with the note name and cent value shown in the LCD display.

Press the ◀ or ▶ buttons to select the note to adjust, then press the ▲ or ▼ buttons to increase or decrease the cent value.

* Each note can be adjusted within the range of -50 to +50 cents.

Press a SOUND SELECT button to exit the Temperament setting and return to normal operation.

```
2-7 Temperament
= User +Hold[F]
```

```
2-7 User C
= 0
```

8 Key of Temperament

The Key of Temperament setting allows the key of the selected temperament to be specified. When using a temperament other than equal temperament, use this setting to specify the key signature of the piece.

* This setting will only affect the 'balance' of the tuning system, the pitch of the keyboard will remain unchanged.

1. Selecting the Key of Temperament setting

Enter the Virtual Technician menu (page 54).

Press the ◀ or ▶ buttons to select the Key of Temperament setting.



2-8 KeyOfTemPer
= C

2. Changing the Key of Temperament key

Press the ▲ or ▼ buttons to select the desired Key of Temperament key.

* The key of temperament key can be set within the range of C to B.

Press a SOUND SELECT button to exit the Key of Temperament setting and return to normal operation.



2-8 KeyOfTemPer
= C#

Key Settings

The Key Settings menu contains settings that affect instrument operation when using the Dual or Split modes.

■ Key Settings

Page no.	Setting name	Explanation	Default setting
1	Lower Octave Shift	Raise the pitch of the lower section in octave steps when using Split mode.	0
2	Lower Pedal On/Off	Enable/disable sustain pedal for the lower section when using Split mode.	Off
3	Layer Octave Shift	Raise the pitch of the layered sound in octave steps when using Dual mode.	0
4	Layer Dynamics	Adjust the dynamic sensitivity of the layered sound when using Dual mode.	10

* Default settings will be shown in the first LCD display illustration (i.e. Step 1) for each setting explanation below.

■ Entering the Key Settings menu

Press the FUNCTION button to enter the Functions menu.

Press the ▲ or ▼ buttons to select the Key Settings menu.

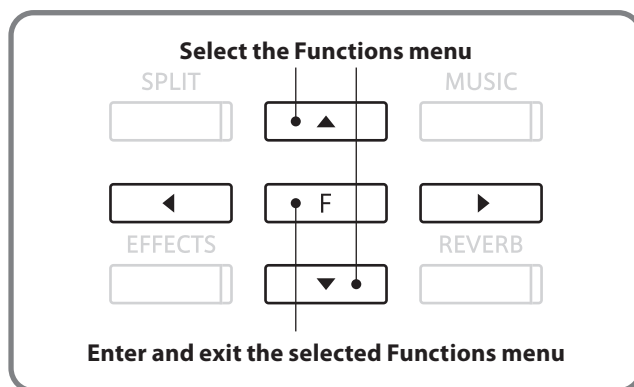
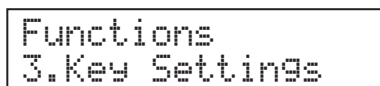

■ Selecting the desired setting

After entering the Key Settings menu:

Press the ◀ or ▶ buttons to cycle through the different settings pages.

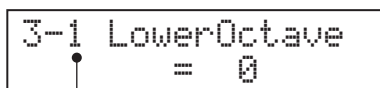

Settings page number

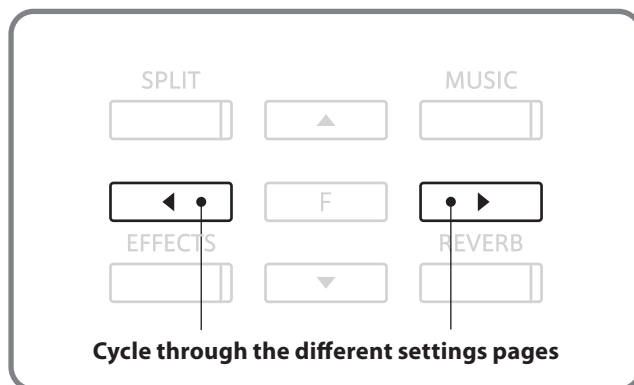

1 Lower Octave Shift

The Lower Octave Shift setting allows the pitch of the lower section when using Split mode to be raised in octave steps.

1. Selecting the Lower Octave Shift setting

Enter the Key Settings menu (page 64).

The Lower Octave Shift setting will be selected automatically.

```
3-1 LowerOctave
    = 0
```

2. Adjusting the Lower Octave Shift value

Press the ▲ or ▼ buttons to increase or decrease the value of the Lower Octave Shift setting.

* The lower section pitch can be raised by up to 3 octaves.

Press a SOUND SELECT button to exit the Lower Octave Shift setting and return to normal operation.

```
3-1 LowerOctave
    = 1
```

2 Lower Pedal

The Lower Pedal setting determines whether or not the sustain pedal will affect (i.e. sustain) the lower sound when using Split mode.

1. Selecting the Lower Pedal setting

Enter the Key Settings menu (page 64).

Press the ◀ or ▶ buttons to select the Lower Pedal setting.

```
3-2 Lower Pedal
    = Off
```

2. Changing the Lower Pedal setting

Press the ▲ or ▼ buttons to turn the Lower Pedal setting on/off.

* When set to 'On', the sustain pedal will sustain the lower section sound.

Press a SOUND SELECT button to exit the Lower Pedal setting and return to normal operation.

```
3-2 Lower Pedal
    = On
```

3 Layer Octave Shift

The Layer Octave Shift setting allows the pitch of the layered sound (shown in the second line of the LCD display) when using Dual mode to be raised or lowered in octave steps.

1. Selecting the Layer Octave Shift setting

Enter the Key Settings menu (page 64).

Press the ◀ or ▶ buttons to select the Layer Octave Shift setting.



3-3 LayerOctave
= 0

2. Adjusting the Layer Octave Shift value

Press the ▲ or ▼ buttons to increase or decrease the value of the Layer Octave Shift setting.

* The layered sound pitch can be raised or lowered by up to 2 octaves.

Press a SOUND SELECT button to exit the Layer Octave Shift setting and return to normal operation.

* Some layered sounds may not produce a sound when the octave range is raised beyond a certain value.

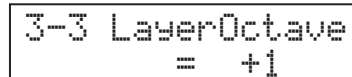

3-3 LayerOctave
= +1

4 Layer Dynamics

When using Dual mode, sometimes simply adjusting the volume balance between the two layered sounds is not enough to create the desired sound character, especially if both sounds are very dynamic. Layering two equally dynamic sounds can prove difficult to control and play comfortably.

The Layer Dynamics Function allows the dynamic sensitivity of the layered sound to be reduced, in order to improve the blend between the two combined sounds. In addition to reducing the volume of the layered sound, limiting its dynamic sensitivity also allows the layered sound to be controlled more easily in relation to the main sound.

1. Selecting the Layer Dynamics setting

Enter the Key Settings menu (page 64).

Press the ◀ or ▶ buttons to select the Layer Dynamics setting.



```
3-4 LayerDynamic
    = 10
```

2. Adjusting the Layer Dynamics value

Press the ▲ or ▼ buttons to increase or decrease the Layer Dynamics value.

* The layer dynamics value can be adjusted within the range of 1-10.

Press a SOUND SELECT button to exit the Layer Dynamics setting and return to normal operation.



```
3-4 LayerDynamic
    = 9
```

About MIDI

The term MIDI is an acronym for Musical Instrument Digital Interface, an international standard for connecting musical instruments, computers, and other devices to allow the exchange of performance data.

■ MIDI terminals

MIDI terminal	Function
MIDI IN	Receiving note, program change, and other data.
MIDI OUT	Sending note, program change, and other data.
MIDI THRU	Passing along MIDI data to another MIDI device without processing.

■ MIDI channels

MIDI uses channels to exchange data back and forth between MIDI devices. There are receive (MIDI IN) and transmit (MIDI OUT) channels. Most musical instruments or devices with MIDI functions are equipped with both MIDI IN and OUT jacks and are capable of transmitting and receiving data via MIDI. The receive channels are used to receive data from another MIDI device and the transmit channels are used to transmit data to another MIDI device.

The illustration below shows three musical instruments, connected together using MIDI.

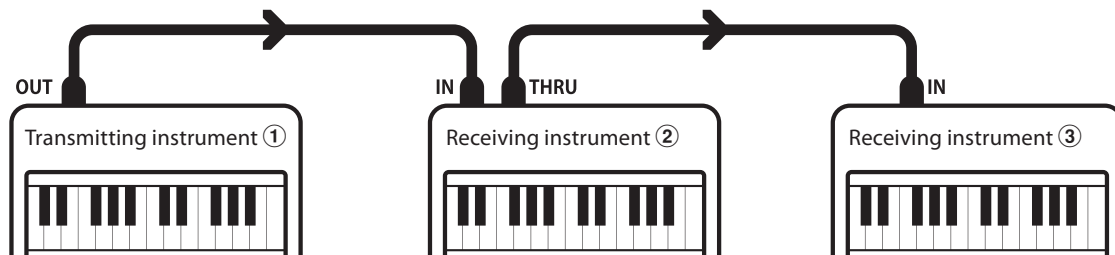

Transmitting instrument ① sends transmit channel and keyboard information to receiving instruments ②/③. The information arrives at the receiving instruments ②/③. Receiving instruments ②/③ will respond to MIDI data that is sent if their receive channel is the same as the transmit channel of the transmitting instrument ①. If the channels do not match, then the receiving instruments ②/③ will not respond to any data that is sent.

For both receiving and transmitting, channels 1-16 can be used.

■ Recording/playing with a sequencer

When connected to a sequencer, the CS6 digital piano can be used to record and playback multi-track songs, with separate sounds playing simultaneously on each channel.

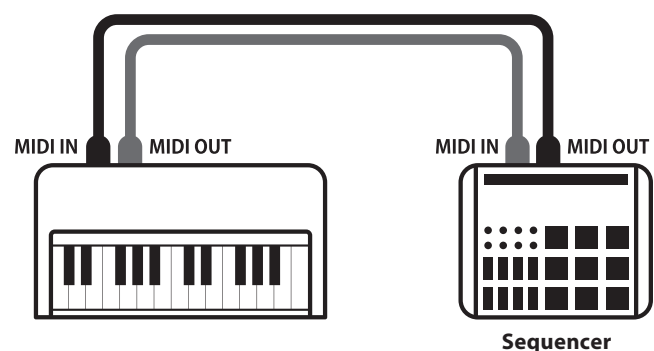

■ MIDI functions

The CS6 digital piano supports the following MIDI functions:

Transmit/receive note information

Transmit/receive note information from a MIDI-connected musical instrument or device.

Transmit/receive channel settings

Specify transmit/receive channels within the range of 1 to 16.

Transmit recorder playback data

Songs recorded using the recorder can be played back from a MIDI-connected musical instrument or recorded by an external sequencer via the MIDI OUT jack.

Transmit/receive exclusive data

Transmit/receive front panel or menu function settings as exclusive data.

Transmit/receive Program Change number

Transmit/receive program change data to/from a MIDI-connected musical instrument or device.

Transmit/receive pedal data

Transmit/receive sustain, sostenuto, and soft pedal data from a MIDI-connected musical instrument or device.

Multi-timbral setting

Receive multiple channel MIDI data from a MIDI-connected musical instrument or device.

* Multi-timbral setting must be enabled.

Receive volume data

Receive MIDI volume data sent from a MIDI-connected musical instrument or device.

* Please refer to the 'MIDI Implementation Chart' (page 95) for further details regarding the MIDI capabilities of the CS6 digital piano.

■ Entering the MIDI Settings menu

Press the FUNCTION button to enter the Functions menu.

Press the ▲ or ▼ buttons to select the MIDI Settings menu.

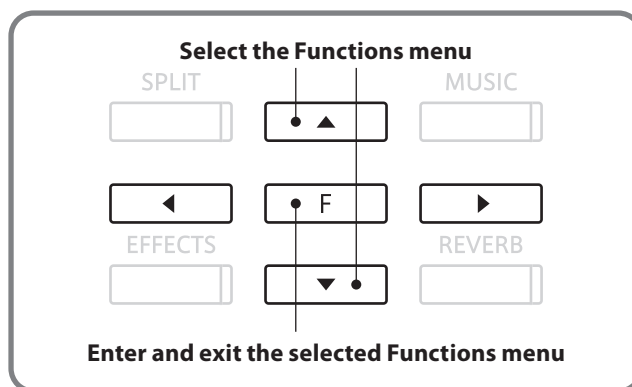

■ Selecting the desired setting

After entering the MIDI Settings menu:

Press the ◀ or ▶ buttons to cycle through the different settings pages.

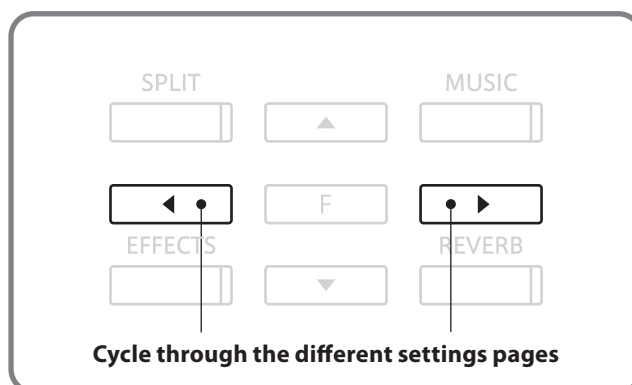

MIDI Settings

1 MIDI Channel (transmit/receive)

The MIDI Channel setting allows the transmit/receive channel to be specified. The selected channel will function as both the transmit and receive channel (separate transmit/receive channels cannot be specified).

1. Selecting the MIDI Channel settings

Enter the MIDI Settings menu (page 69).

The MIDI Channel setting will be selected automatically.

```
4-1 MIDI Channel
= 1 (TR5/RCU)
```

2. Changing the MIDI Channel value

Press the ▲ or ▼ buttons to increase or decrease the MIDI Channel value.

* The MIDI channel value can be set within the range of 1-16.

Press a SOUND SELECT button to exit the MIDI Channel setting and return to normal operation.

```
4-1 MIDI Channel
= 2 (TR5/RCU)
```

■ Omni mode

When the CS6 digital piano is turned on, the instrument is automatically set to 'omni mode on', allowing MIDI information to be received on all MIDI channels (1-16). When the MIDI Channel setting is used to specify a transmit/receive channel, the instrument will be set to 'omni mode off'.

■ Multi-timbral mode and Split/Dual mode

Using Split mode with Multi-timbral mode enabled

Notes played in the lower section of the keyboard will be transmitted on the channel that is 1 channel higher than the specified channel. For example, if the MIDI channel is set to 3, notes played in the lower section of the keyboard will be transmitted on channel 4.

Using Dual mode with Multi-timbral mode enabled

Notes played will be transmitted on two channels: the specified channel and the channel that is 1 channel higher.

* If the specified channel is 16, the lower section / layered part will be transmitted on channel 1.

2 Send Program Change Number

The Send Program Change Number function allows the CS6 digital piano to transmit a program change number from 1 to 128.

1. Selecting the Send Program Change Number function

Enter the MIDI Settings menu (page 69).

Press the ◀ or ▶ buttons to select the Send Program Change Number function.

```
4-2 Send PGM #  
= 1 (UP+DOWN)
```

2. Specifying and transmitting a program change number

Press the ▲ or ▼ buttons to increase or decrease the Program Change Number.

* The program change number can be set within the range of 1-128.

Press the ▲ and ▼ buttons simultaneously so send the specified Program Change Number.

Press a SOUND SELECT button to exit the Send Program Change Number function and return to normal operation.

```
4-2 Send PGM #  
= 2 (UP+DOWN)
```

3 Local Control

The Local Control setting determines whether the instrument will play an internal sound when the keys are pressed. This setting is useful when using the CS6 digital piano to control an external MIDI device.

Local Control settings

Local Control setting	Explanation
On	The instrument will play an internal sound and transmit information to an external MIDI device.
Off	The instrument will transmit information to an external MIDI device only.

1. Selecting the Local Control setting

Enter the MIDI Settings menu (page 69).

Press the ◀ or ▶ buttons to select the Local Control setting.

```
4-3 LocalControl  
= On
```

2. Changing the Local Control setting

Press the ▲ or ▼ buttons to turn the Local Control setting on/off.

Press a SOUND SELECT button to exit the Local Control setting and return to normal operation.

```
4-3 LocalControl  
= Off
```

4 Transmit Program Change Numbers

The Transmit Program Change Numbers setting determines whether or not the CS6 digital piano will transmit program change information via MIDI when the instrument's panel buttons are pressed.

■ Transmit Program Change Number settings

Transmit PGM# setting	Multi-timbral setting	Effect of pressing panel buttons
On	Off, On1	SOUND SELECT buttons will send PGM# shown in the left column*.
On	On2	SOUND SELECT buttons will send PGM# shown in the right column*.
Off	n/a	No Program Change information will be transmitted via MIDI.

* Please refer to the 'Program Change Number List' on pages 89-90.

1. Selecting the Transmit Program Change Numbers setting

Enter the MIDI Settings menu (page 69).

Press the ◀ or ▶ buttons to select the Transmit Program Change Numbers setting.

```
4-4 TransmitPGM#
    = On
```

2. Changing the Transmit Program Change Numbers setting

Press the ▲ or ▼ buttons to turn the Transmit Program Change Numbers setting on/off.

Press a SOUND SELECT button to exit the Transmit Program Change Numbers setting and return to normal operation.

```
4-4 TransmitPGM#
    = Off
```

■ Program Change Numbers and Dual/Split mode

- When using Dual or Split mode, On/Off information and sound type settings for are transmitted as exclusive data, however program change numbers will not be transmitted.
- Program change numbers will also be transmitted when Multi-timbral mode is set to On1 or On2.

5 Multi-timbral Mode

The Multi-timbral Mode setting determines whether or not the CS6 digital piano is able to receive MIDI information on more than one MIDI channel simultaneously. This allows the instrument to play back multi-track, multi-timbral performance data sent from an external MIDI device.

Multi-timbral Mode settings

Multi-timbral Mode setting	Effect on sound heard
Off, On1	The sound shown in the left column is selected*.
On2	The sound shown in the right column is selected*.

* Please refer to the 'Program Change Number List' on pages 89-90.

1. Selecting the Multi-timbral Mode setting

Enter the MIDI Settings menu (page 69).

Press the ◀ or ▶ buttons to select the Multi-timbral Mode setting.

```
4-5 Multi Timbre
      = Off
```

2. Changing the Multi-timbral Mode setting

Press the ▲ or ▼ buttons to change the Multi-timbral Mode setting.

Press a SOUND SELECT button to exit the Multi-timbral Mode setting and return to normal operation.

```
4-5 Multi Timbre
      = On1
```

* When multi-timbral mode is set to on, sounds received via MIDI on the receive channels will be played even when using Split mode.

6 Channel Mute

The Channel Mute setting determines which MIDI channels (1-16) are activated to receive MIDI information when Multi-timbral mode is enabled. This setting is available only when Multi-timbral mode is enabled.

1. Selecting the Channel Mute setting

Enter the MIDI Settings menu (page 69).

Press the ◀ or ▶ buttons to select the Channel Mute setting.

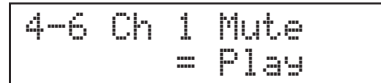

2. Changing the Channel Mute setting

Press the ◀ or ▶ buttons to select the MIDI channel.

Press the ▲ or ▼ buttons to change the Channel Mute setting to Play/Mute.

Press a SOUND SELECT button to exit the Transmit Program Change Numbers setting and return to normal operation

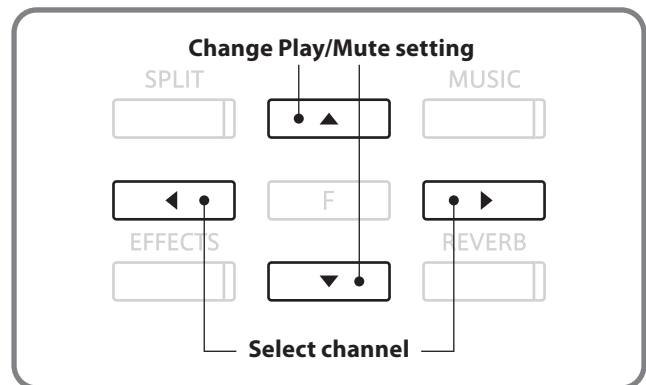

USB MIDI (USB to Host connector)

The CS6 digital piano features a 'USB to Host' type connector, allowing the instrument to be connected to a computer and utilised as a MIDI device. Depending on the type of computer and operating system installed, additional driver software may be required for USB MIDI communication to function correctly.

■ USB MIDI driver

Operating System	USB MIDI Driver Support
Windows ME Windows XP (no SP, SP1, SP2, SP3) Windows XP 64-bit Windows Vista (SP1, SP2) Windows Vista 64-bit (SP1, SP2) Windows 7 Windows 7 64-bit	<p>Additional USB MIDI driver software NOT required.</p> <p>The standard (built-in) Windows USB MIDI driver will be installed automatically when the instrument is connected to the computer.</p> <p>* After driver installation, ensure that the 'USB Audio Device' (Windows ME/Windows XP) or 'USB-MIDI' (Windows Vista/Windows 7) device is correctly selected in the application software.</p>
Windows 98 SE Windows 2000 Windows Vista (no SP)	<p>Additional USB MIDI driver software required.</p> <p>Please download the USB MIDI driver from the Kawai website: → http://www.kawai.co.jp/english</p> <p>* After driver installation, ensure that the 'Kawai USB MIDI' device is correctly selected in the application software.</p>
Windows Vista 64-bit (no SP)	<p>USB MIDI is not supported.</p> <p>Please upgrade to service pack 1 or service pack 2.</p>
Mac OS X	<p>No additional USB MIDI driver software required.</p> <p>The standard (built-in) Mac OS X USB MIDI driver will be installed automatically when the instrument is connected to the computer.</p>
Mac OS 9	<p>USB MIDI is not supported.</p> <p>Please use the standard MIDI IN/OUT connectors.</p>

■ USB MIDI information

- If the instrument's MIDI IN/OUT jacks and USB MIDI port are both connected simultaneously, the USB MIDI port will be given priority.
- Ensure that the instrument is turned off before attempting to connect the USB MIDI cable.
- When connecting the instrument to a computer using the USB MIDI port, there may be a short delay before communications begin.
- If the instrument is connected to a computer via a USB hub and USB MIDI communication becomes unreliable/unstable, please connect the USB MIDI cable directly to the one of the computer's USB ports.
- Disconnecting the USB MIDI cable suddenly, or turning the instrument on/off while using USB MIDI may cause computer instability in the following situations:
 - while installing the USB MIDI driver
 - while starting up the computer
 - while MIDI applications are performing tasks
 - while the computer is in energy saver mode
- If there are any further problems experienced with USB MIDI communication while the instrument is connected, please double-check all connections and relevant MIDI settings in the computer's operating system.



The USB MIDI conversion board TID10000934 utilised by the CS6 digital piano is approved to show the USB logo. This USB logo can be used only for products approved by the USB-IF (USB Implements Forum Inc.) test.

* 'MIDI' is a registered trademark of the Association of Manufacturers of Electronic Instruments (AMEI).
 * 'Windows' is registered trademark of Microsoft Corporation.
 * 'Macintosh' is registered trademark of Apple Computer, Inc.
 * Other company names and product names mentioned referenced herein may be registered trademarks or trademarks of respective owners.

USB Menu

The USB Menu contains functions to load and save recorder songs from/to a USB memory device. This menu also allows files to be renamed and deleted, and for the USB memory device to be formatted.

■ USB Menu

Page no.	Function name	Explanation
1	Load Song	Load a recorder song from a USB memory device into the instrument's internal memory.
2	Save Song	Save a recorder song stored in internal memory to a USB memory device.
3	Rename	Rename a file stored on a USB memory device.
4	Delete	Delete a file stored on a USB memory device.
5	Format	Format a USB memory device, erasing all stored data.

■ Entering the USB menu

Press the FUNCTION button to enter the Functions menu.

Press the ▲ or ▼ buttons to select the USB menu.

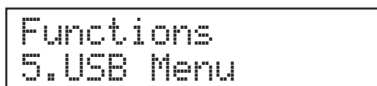

Press the FUNCTION button again to enter the menu.

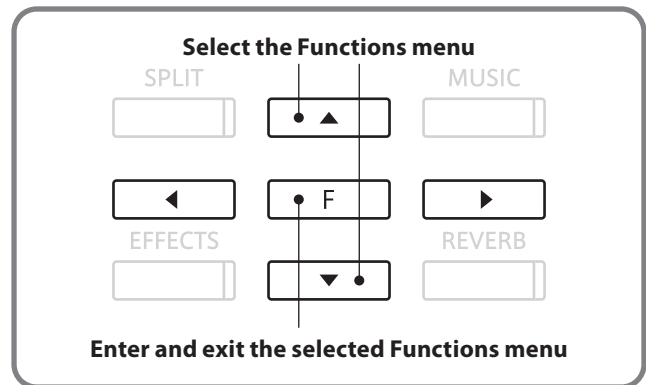

■ Selecting the desired function

After entering the USB menu:

Press the ◀ or ▶ buttons to cycle through the different function pages, then press the FUNCTION button.

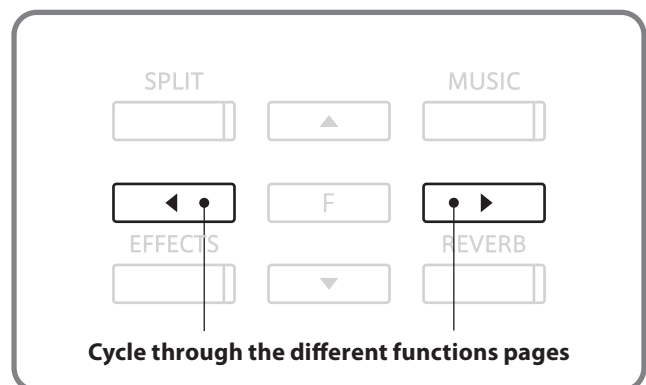
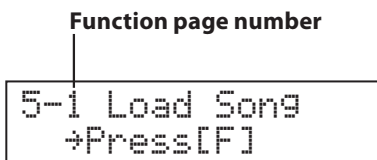

1 Load Song

The Load Song function allows recorder songs stored on a USB memory device to be loaded into the instrument's internal memory.

1. Selecting the Load Song function

Enter the USB menu (page 76).

The Load Song function will be selected automatically.

Press the FUNCTION button.

A rectangular LCD display showing the text "5-1 Load Song" on the top line and "→Press[F]" on the bottom line.

2. Selecting the location for the song

Press the ▲ or ▼ buttons to select the location (song number) that the song will be loaded into.

* Up to 10 different songs can be loaded and stored in internal memory.

If the selected song location already contains recorder song data, a ✱ symbol will be shown.

* Any existing recorder song data will be replaced by the loaded song.

Press the FUNCTION button.

A rectangular LCD display showing the text "Load Song" on the top line and "Song 1" on the bottom line.



A rectangular LCD display showing the text "Load Song" on the top line and "Song 10*" on the bottom line.

— Song contains recorder data

3. Selecting the song to be loaded

Press the ▲ or ▼ buttons to select the song to be loaded into internal memory.

Press the FUNCTION button.

A rectangular LCD display showing the text "Load Song" on the top line and "IntSong 1" on the bottom line.

4. Loading the song

A confirmation message will be shown in the LCD display, prompting to confirm the load song operation.

Press the ◀ or ▶ buttons to cancel or confirm the operation.

After loading a song, please follow the 'Playing back a song' instructions on page 38.

A rectangular LCD display showing the text "Are you sure?" on the top line and "←No Yes→" on the bottom line.

5. Exiting the Load Song function

Press a SOUND SELECT button to exit the Load Song function and return to normal operation

2 Save Song

The Save Song function allows recorder songs stored in the instrument's internal memory to be saved to a USB memory device. Once saved, this data can be played back or edited using computer software.

1. Selecting the Save Song function

Enter the USB menu (page 76).

Press the ◀ or ▶ buttons to select the Save Song function, then press the FUNCTION button.

```
5-2 Save Song
  →Press[F]
```

2. Selecting the song to be saved

Press the ▲ or ▼ buttons to select the recorder song to be saved to a USB memory device.

If the selected recorder song contains song data, a * symbol will be shown.

Press the FUNCTION button.

```
Save Song
Song 1*
```

Song contains
recorder data

3. Naming the song

Press the ▲ or ▼ buttons to cycle through the alphanumeric characters, and the ◀ or ▶ buttons to move the cursor.

Press the FUNCTION button.

```
Name ? →Press[F]
IntSong_1
```

4. Saving the song

A confirmation message will be shown in the LCD display, prompting to confirm the save song operation.

Press the ◀ or ▶ buttons to cancel or confirm the operation.

```
Are you sure?
←No                Yes→
```

* Saved songs are limited to a maximum name length of 12 characters.

* The saved song file will be stored in the root folder of the USB memory device. It is not possible to store the song file in a different folder.

* Renaming or re-saving the song file using a computer may prevent the song from being loaded into the instrument's internal memory.

5. Exiting the Save Song function

Press a SOUND SELECT button to exit the Save Song function and return to normal operation

3 Rename

The Rename function allows song and audio files stored on a USB memory device to be renamed.

1. Selecting the Rename function

Enter the USB menu (page 76).

Press the ◀ or ▶ buttons to select the Rename function, then press the FUNCTION button.

```
5-3 Rename
  +Press[F]
```

2. Selecting the file to be renamed

Press the ▲ or ▼ buttons to select the file to be renamed.

Press the FUNCTION button.

```
Rename
MP3 Song 03 .MP3
```

3. Renaming the file

Press the ▲ or ▼ buttons to cycle through the alphanumeric characters, and the ◀ or ▶ buttons to move the cursor.

Press the FUNCTION button.

A confirmation message will be shown in the LCD display, prompting to confirm the rename operation.

Press the ◀ or ▶ buttons to cancel or confirm the operation confirmation message will appear.

```
Name ? +Press[F]
James' _song .MP3
```

```
Are you sure?
+No           Yes+
```

4. Exiting the Rename function

Press a SOUND SELECT button to exit the Rename function and return to normal operation.

■ Overwriting the file

If the specified name already exists:

A confirmation message will be shown in the LCD display, prompting to confirm the rename operation.

Press the ◀ or ▶ buttons to cancel or confirm the operation.

```
Overwrite file?
+No           Yes+
```

4 Delete

The Delete function allows song and audio files stored on a USB memory device to be deleted.

1. Selecting the Delete function

Enter the USB menu (page 76).

Press the ◀ or ▶ buttons to select the Delete function, then press the FUNCTION button.

A rectangular LCD display showing the text "5-4 Delete" on the first line and "+Press[F]" on the second line.

2. Selecting the file to be deleted

Press the ▲ or ▼ buttons to select the file to be deleted, then press the FUNCTION button.

A rectangular LCD display showing the text "Delete" on the first line and "James'_song .MP3" on the second line.

3. Deleting the file

A confirmation message will be shown in the LCD display, prompting to confirm the delete operation.

Press the ◀ or ▶ buttons to cancel or confirm the operation.

A rectangular LCD display showing the text "Are you sure?" on the first line and "+No Yes+" on the second line.

4. Exiting the Delete function

Press a SOUND SELECT button to exit the Delete function and return to normal operation.

5 Format

The Format function allows a USB memory device to be formatted, erasing all stored data.

1. Selecting the Format function

Enter the USB menu (page 76).

Press the ◀ or ▶ buttons to select the Format function, then press the FUNCTION button.

A rectangular box representing an LCD display. The text inside is arranged in two lines: the first line reads "5-5 Format" and the second line reads "+Press[F]".

2. Formatting the USB memory device

A confirmation message will be shown in the LCD display, prompting to confirm the format operation.

Press the ◀ or ▶ buttons to cancel or confirm the operation.

A rectangular box representing an LCD display. The text inside is arranged in two lines: the first line reads "Format ?" and the second line reads "+No Yes+".

A second confirmation message will be shown in the LCD display, prompting to confirm the format operation.

Press the ◀ or ▶ buttons to cancel or confirm the operation.

A rectangular box representing an LCD display. The text inside is arranged in two lines: the first line reads "Are you sure?" and the second line reads "+No Yes+".

3. Exiting the Format function

Press a SOUND SELECT button to exit the Format function and return to normal operation.

Power Setting menu

1 Auto Power Off

The CS6 features a power saving function that can be used to automatically turn off the instrument after a specified period of inactivity.

■ Auto Power Off setting

Auto Power Off setting	Explanation
Off	The Auto Power Off function is disabled.
30 min.	The instrument will turn off automatically after 30 minutes of inactivity.
60 min.	The instrument will turn off automatically after 60 minutes of inactivity.
120 min.	The instrument will turn off automatically after 120 minutes of inactivity.

■ Entering the Power Setting menu

Press the FUNCTION button to enter the Functions menu.

Press the ▲ or ▼ buttons to select the Power Setting menu.

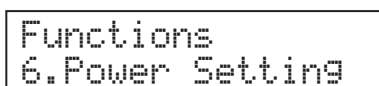

Press the FUNCTION button again to enter the menu.

The Auto Power Off setting will be selected automatically.

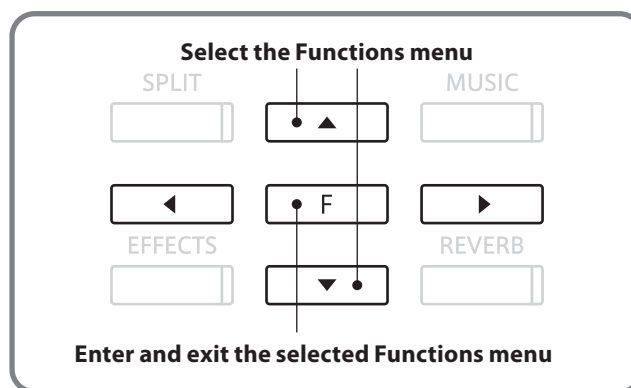

1. Changing the Auto Power Off setting

Press the ▲ or ▼ buttons to increase or decrease the value of the Auto Power Off setting.

* The Auto Power Off value can be set within the range of Off-120 mins.

Press a SOUND SELECT button to exit the Auto Power Off setting and return to normal operation.

The Auto Power Off setting will be stored in the instrument's memory and automatically recalled every time the CS6 digital piano is turned on.

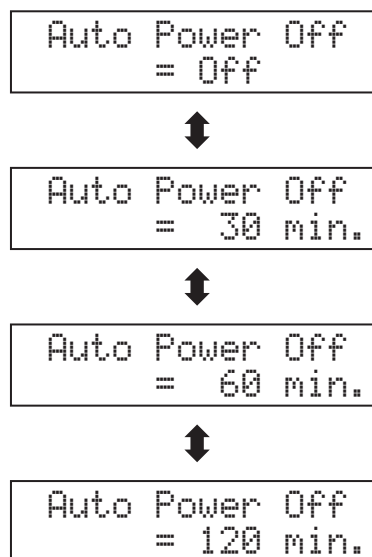

Troubleshooting

	Problem	Possible Cause and Solution	Page no.
Power	The instrument does not turn on.	Check that the power cable is firmly attached to the instrument, and connected to an AC outlet.	p. 12
	The instrument is turned on, however no sound is produced when the keys are played.	Check that the MASTER VOLUME slider is not set to the lowest position.	p. 13
Check that a pair of headphones (or headphone adaptor plug) are not connected connected to the PHONES jack.		p. 13	
Check that Local Control is enabled in the MIDI Settings menu.		p. 71	
Sound	The sound distorts when playing at very loud volume levels.	Check that the MASTER VOLUME slider is set to an appropriate level, reducing the volume if excessive distortion is heard.	p. 13
	Strange sounds or noises are heard when playing with piano sounds.	The CS6 digital piano attempts to reproduce the rich variety of tones created by an acoustic grand piano as accurately as possible. This includes string resonances and damper noises, and other subtle characteristics that contribute to the overall piano playing experience. While these additional tones are intended to enhance the realism of the instrument, it is possible to reduce their prominence, or disable the effects altogether using the functions in the Virtual Technician menu.	p. 54
Headphones	The headphone volume is too low.	Check the technical specifications of the headphones. If the 'Nominal Impedance' specification of the headphones is less than 100 Ω (ohms), please set the 'Phones Volume' setting in the 'Basic Settings' menu to 'High'.	p. 50
Pedals	The pedals are unreliable or do not function at all.	Check that the pedal cable is firmly connected to the instrument.	p. 93
	When depressing a pedal, the pedal board flexes and is not firm.	Check that the pedal support bolt is fully extended.	p. 15
USB	A USB memory device is not detected, cannot be saved to, or does not appear to function when connected to the 'USB to Device' port.	Check that the USB memory device is formatted to use the FAT/FAT32 filesystem, and not set to 'Write Protect' mode. Disconnect the USB memory device, turn the instrument off then on, then reconnect the USB memory device. If the USB memory device still does not function, it may be damaged or incompatible. Please try using a different USB memory device.	p. 85
	The instrument pauses briefly when connecting a USB memory device.	This is recognised behaviour when using very large capacity (e.g. 8GB+) USB memory devices.	p. 85
MP3/WAV/SMF Audio	No sound can be heard when playing an MP3/WAV audio file stored on a USB memory device.	Check that the audio player volume is not set to 0.	p. 43
		Check that the format of the audio file is supported and listed in the 'Audio Player supported format specifications' table.	p. 42
	An MP3/WAV audio file stored on a USB memory device sounds strange, or does not play back at all.	Check that the format of the audio file is supported and listed in the 'Audio Player supported format specifications' table.	p. 42
		The file transfer speed of the USB memory device may be too slow to play the audio file. Please try using a different USB memory device, ensuring that it conforms to USB2.0 Hi-Speed standards.	p. 85
An SMF MIDI file stored on a USB memory device sounds strange when played back.	The CS6 digital piano does not contain the full General MIDI sound bank selection. Consequently, some SMF song files may not be reproduced entirely accurately when played through the instrument.	p. 44	

Connecting to Other Devices

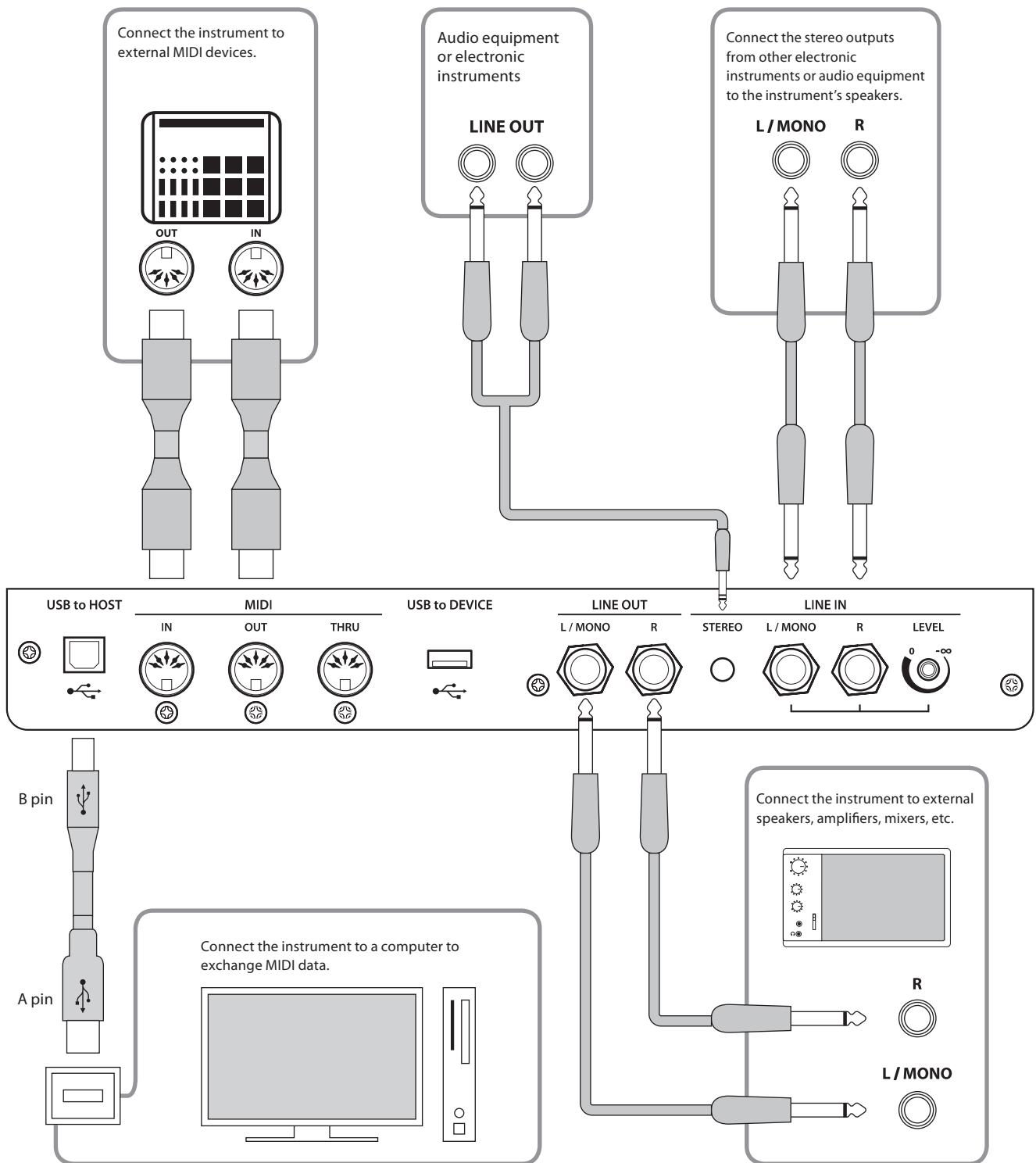

- Before connecting the CS6 digital piano to other devices, ensure that the power to both the instrument and the other device is turned off. If connections are established while the power is turned on, extraneous noise that can damage the CS6 digital piano may activate the instrument's amplifier protection circuit, preventing any sound from being produced. If this occurs, turn the power off and then on again to reset the amplifier protection circuit.
- Do not connect the LINE IN and LINE OUT jacks of the CS6 digital piano together with a cable. An audio loop (oscillation sound) will occur, resulting in damage to the unit.

■ LINE IN jacks (1/4" phone jack)

These jacks are used to connect a pair of stereo outputs from other electronic instruments or audio equipment to the instrument's speakers. The audio signal from these jacks bypasses the MASTER VOLUME control, however the the LINE IN level can be adjusted using the adjustment knob, or by adjusting the output level of the connected device. To connect a device in mono, connect the cable to the L/MONO jack only.

■ LINE OUT jacks (1/4" phone jack)

These jacks provide stereo output of the instrument's sound to external speakers, amplifiers, mixers, recording devices, and similar equipment. The audio signal from the LINE IN jacks is also routed to these jacks. The MASTER VOLUME slider can be used to control the output level of the instrument's own sound without affecting the level of the LINE IN signal. Mono signals will be output only if a cable is connected to the L/MONO jack.

■ USB to Host port ('B' type)

This USB port is used to connect the CS6 digital piano to a computer using an inexpensive USB cable. When connected, the instrument can be used as a standard MIDI device, allowing it to send a receive MIDI data. Connect a 'B' type USB connector to the instrument, and an 'A' type USB connector to the computer.

■ MIDI IN/OUT/THRU jacks

These jacks are used to connect the CS6 digital piano to external MIDI devices, and also to a computer with a MIDI interface as an alternative to the 'USB to Host' port.

■ USB device information

- The 'USB to Device' functionality of the CS6 digital piano conforms to USB2.0 Hi-Speed standards. Older USB devices can still be used, however data transfer speed will be limited to the maximum transfer speed of the device.
- The 'USB to Device' port is intended for connecting USB memory devices. USB floppy drive devices can be used to save recorder songs stored in internal memory, or play SMF song files, yet are not suitable for MP3/WAV audio file playback or recording.

■ LINE IN STEREO jack (1/8" mini jack)

This jack is used to connect the stereo output from an external audio device, such as a CD or MP3 player, to the instrument's speakers. The LINE IN adjustment knob cannot be used to adjust the LINE IN level, therefore please use the volume controls on device itself.

■ PHONES jacks (1/4" phone jack)

These jacks are used to connect stereo headphones to the CS6 digital piano. Two pairs of headphones can be connected and used simultaneously. When a pair of headphones is connected, sound will not be produced by the speakers.

■ USB to Device port ('A' type)

This USB port is used to connect a USB memory device to the CS6 digital piano. This allows MP3/WAV audio files, and SMF song files to be played directly. It is also possible to record performances to MP3/WAV audio files, and save recorder songs stored in internal memory for posterity.

- It may be necessary to format the USB memory device before it can be used with the CS6 digital piano. If so, please refer to the 'Format' function instructions on page 81. Formatting the device will erase all data.
- Avoid removing the USB memory device while data is being loaded or saved, files are being renamed or deleted, or the device is being formatted.
- Other USB devices, such as computer mice, keyboards, or battery chargers etc. cannot be used with this instrument.

Sound List

PIANO 1

Concert Grand
Concert Grand 2
Studio Grand
Studio Grand 2
Mellow Grand
Mellow Grand 2
Jazz Grand
Jazz Grand 2

PIANO 2

Pop Piano
Pop Piano 2
Modern Piano
Rock Piano

E. PIANO

Classic E.Piano
Modern E.P.
60's E.P.
Modern E.P. 2
New Age E.P.
Crystal E.P.

ORGAN

Jazz Organ
Drawbar Organ
Drawbar Organ 2
Be 3
Jazzer
Odd Man
Church Organ
Diapason
Full Ensemble
Diapason Oct.
Chiffy Tibia
Stopped Pipe

HARPSI & MALLETS

Harpsichord
Harpsichord 2
Vibraphone
Clavi
Marimba
Celesta

STRINGS

Slow Strings
String Pad
Warm Strings
String Ensemble
Soft Orchestra
Harp

VOCAL & PAD

Choir
Pop Ooh
Pop Aah
Choir 2
Jazz Ensemble
Pop Ensemble
New Age Pad
Atmosphere
Itopia
Brightness
New Age Pad 2
Brass Pad

BASS & GUITAR

Wood Bass
Finger Bass
Fretless Bass
W. Bass & Ride
Ballad Guitar
Pick Nylon Gt.

Demo Song List

No.	Sound	Song	Composer
PIANO 1			
1	Concert Grand	Liebesträume No.3	Liszt
2	Concert Grand 2	Petit chien	Chopin
3	Studio Grand	Original	Kawai
4	Studio Grand 2	Original	Kawai
5	Mellow Grand	Sonata No.30 Op.109	Beethoven
6	Mellow Grand 2	La Fille aux Cheveux de Lin	Debussy
PIANO 2			
7	Pop Piano	Original	Kawai
8	Modern Piano	Original	Kawai
9	Rock Piano	Original	Kawai
ELECTRIC PIANO			
10	Classic E.Piano	Original	Kawai
11	Modern E.P.	Original	Kawai
12	Modern E.P. 2	Original	Kawai
ORGAN			
13	Jazz Organ	Original	Kawai
14	Drawbar Organ	Original	Kawai
15	Drawbar Organ 2	Original	Kawai
16	Church Organ	Toccata	Gigout
17	Diapason	Wohl mir, daß ich Jesum habe	Bach
18	Full Ensemble	Original	Kawai
HARPSI & MALLETS			
19	Harpsichord	French Suite No.6	Bach
20	Vibraphone	Original	Kawai
21	Clavi	Original	Kawai
STRINGS			
22	Slow Strings	Original	Kawai
23	String Pad	Original	Kawai
24	String Ensemble	Le quattro stagioni La primavera	Vivaldi
VOCAL & PAD			
25	Choir	Original	Kawai
26	Choir 2	Original	Kawai
27	Jazz Ensemble	Original	Kawai
28	New Age Pad	Original	Kawai
29	Atmosphere	Original	Kawai
BASS & GUITAR			
30	Wood Bass	Original	Kawai
31	Fretless Bass	Original	Kawai
32	W. Bass & Ride	Original	Kawai
33	Ballad Guitar	Original	Kawai
34	Pick Nylon Gt.	Original	Kawai

Drum Rhythm List

No.	Rhythm
1	8 Beat 1
2	8 Beat 2
3	8 Beat 3
4	16 Beat 1
5	16 Beat 2
6	16 Beat 3
7	16 Beat 4
8	16 Beat 5
9	16 Beat 6
10	Rock Beat 1
11	Rock Beat 2
12	Rock Beat 3
13	Hard Rock
14	Heavy Beat
15	Surf Rock
16	2nd Line
17	50 Ways
18	Ballad 1
19	Ballad 2
20	Ballad 3
21	Ballad 4
22	Ballad 5
23	Light Ride 1
24	Light Ride 2
25	Smooth Beat
26	Rim Beat
27	Slow Jam
28	Pop 1
29	Pop 2
30	Electro Pop 1
31	Electro Pop 2
32	Ride Beat 1
33	Ride Beat 2
34	Ride Beat 3
35	Ride Beat 4
36	Slip Beat
37	Jazz Rock
38	Funky Beat 1
39	Funky Beat 2
40	Funky Beat 3
41	Funk 1
42	Funk 2
43	Funk 3
44	Funk Shuffle 1
45	Funk Shuffle 2
46	Buzz Beat
47	Disco 1
48	Disco 2
49	Hip Hop 1
50	Hip Hop 2

No.	Rhythm
51	Hip Hop 3
52	Hip Hop 4
53	Techno 1
54	Techno 2
55	Techno 3
56	Heavy Techno
57	8 Shuffle 1
58	8 Shuffle 2
59	8 Shuffle 3
60	Boogie
61	16 Shuffle 1
62	16 Shuffle 2
63	16 Shuffle 3
64	T Shuffle
65	Triplet 1
66	Triplet 2
67	Triplet 3
68	Triplet 4
69	Triplet Ballad 1
70	Triplet Ballad 2
71	Triplet Ballad 3
72	Motown 1
73	Motown 2
74	Ride Swing
75	H.H. Swing
76	Jazz Waltz 1
77	Jazz Waltz 2
78	5/4 Swing
79	Tom Swing
80	Fast 4 Beat
81	H.H. Bossa Nova
82	Ride Bossa Nova
83	Beguine
84	Mambo
85	Cha Cha
86	Samba
87	Light Samba
88	Surdo Samba
89	Latin Groove
90	Afro Cuban
91	Songo
92	Bembe
93	African Bembe
94	Merenge
95	Reggae
96	Tango
97	Habanera
98	Waltz
99	Ragtime
100	Country & Western

Program Change Number List

Sound type	Multi-timbral mode = off/on1		Multi-timbral mode = on2	
	Program number	Program number	Bank	
			MSB	LSB
PIANO 1				
Concert Grand	1	1	121	0
Concert Grand 2	2	1	95	16
Studio Grand	3	1	121	1
Studio Grand 2	4	1	95	17
Mellow Grand	5	1	121	2
Mellow Grand 2	6	1	95	18
Jazz Grand	7	1	95	8
Jazz Grand 2	8	1	95	19
PIANO 2				
Pop Piano	9	2	95	10
Pop Piano 2	10	2	95	13
Modern Piano	11	2	121	0
Rock Piano	12	2	121	1
E. PIANO				
Classic E.Piano	13	5	121	0
Modern E.P.	14	6	121	0
60's E.P.	15	5	121	3
Modern E.P. 2	16	6	121	1
New Age E.P.	17	6	95	2
Crystal E.P.	18	6	95	1
ORGAN				
Jazz Organ	19	18	121	0
Drawbar Organ	20	17	121	0
Drawbar Organ 2	21	17	121	1
Be 3	22	17	95	2
Jazzier	23	18	95	1
Odd Man	24	17	95	6
Church Organ	25	20	121	0
Diapason	26	20	95	7
Full Ensemble	27	21	95	1
Diapason Oct.	28	20	95	6
Chiffy Tibia	29	20	95	17
Stopped Pipe	30	20	95	21
HARPSI & MALLETS				
Harpsichord	31	7	121	0
Harpsichord 2	32	7	121	3
Vibraphone	33	12	121	0
Clavi	34	8	121	0
Marimba	35	13	121	0
Celesta	36	9	95	1

Program Change Number List

Sound type	Multi-timbral mode = off/on1		Multi-timbral mode = on2	
	Program number	Program number	Bank	
			MSB	LSB
STRINGS				
Slow Strings	37	45	95	1
String Pad	38	49	95	8
Warm Strings	39	49	95	1
String Ensemble	40	49	121	0
Soft Orchestra	41	50	95	1
Harp	42	47	121	0
VOCAL & PAD				
Choir	43	53	121	0
Pop Ooh	44	54	95	39
Pop Aah	45	54	95	40
Choir 2	46	54	95	53
Jazz Ensemble	47	54	95	2
Pop Ensemble	48	54	95	7
New Age Pad	49	89	121	0
Atmosphere	50	100	121	0
Itopia	51	92	121	1
Brightness	52	101	95	1
New Age Pad 2	53	89	95	2
Brass Pad	54	62	95	2
BASS & GUITAR				
Wood Bass	55	33	121	0
Finger Bass	56	34	121	0
Fretless Bass	57	36	121	0
W. Bass & Ride	58	33	95	1
Ballad Guitar	59	26	95	6
Pick Nylon Gt.	60	25	95	3

Assembly Instruction



Please read these assembly instructions thoroughly before attempting to assemble the CS6 digital piano. Please ensure that two or more people work on assembling the CS6 digital piano, especially when lifting the main body of the instrument onto the stand in step 3.

■ Included parts

Before attempting to assemble the CS6 digital piano, ensure that all parts below are included. A Phillips-head screwdriver (not included) will also be required in order to assemble the instrument.

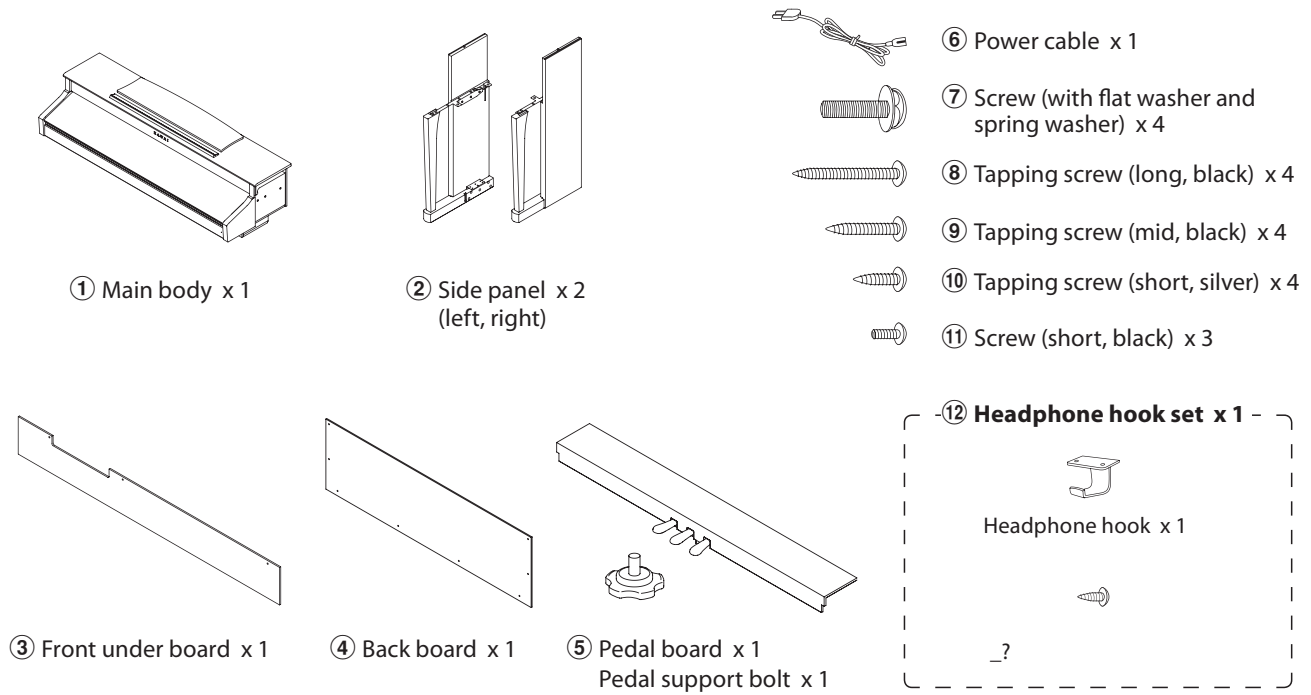

1. Assembling the side panels ②, pedal board, and pedal support bolt ⑤

Unfasten and extend the pedal connection cable attached to the bottom of the pedal board ⑤.

Insert the pedal support bolt approximately 1 cm into the pedal board, using the hole shown in the diagram.

Attach the pedal board ⑤ to the left and right side panels ② using the temporary mounting screws located on either end of the pedal board. Ensure that the correct side panel is used for the left and right side.

Ensure that the pedal board and side panels make close contact, and that there are no large gaps between the assembled parts.

Insert the four short silver tapping screws ⑩ into the holes as shown, and securely fasten the pedal board to the left and right side panels.

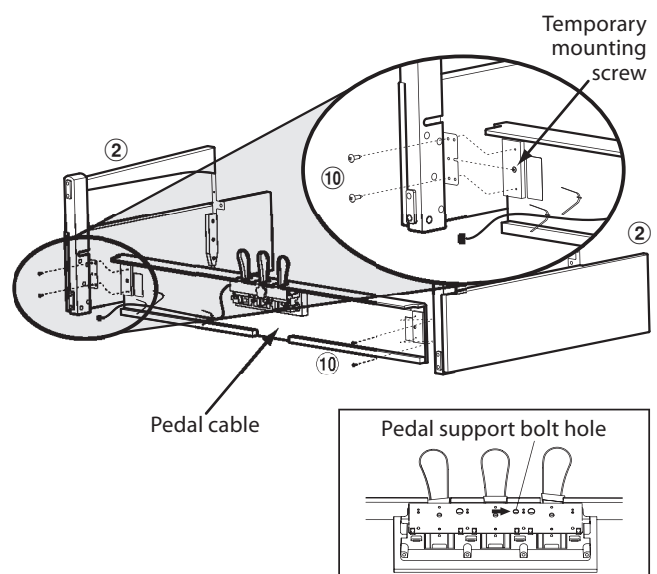

Assembly Instructions

2. Attaching the back board ④

Allow the assembled pedal board and side panels to stand upright (vertically) on the floor.

Temporarily fix the back board ④ to the left and right side panels using the four long black tapping screws ⑧, leaving a tightening allowance of approximately 1-2 mm. Then attach the bottom of the back board to the pedal board using the four mid-length black tapping screws ⑨.

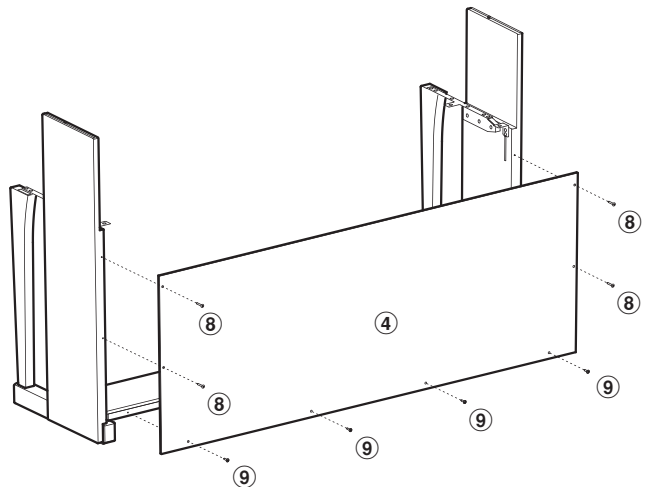

3. Mounting the main body ①



Ensure that two or more people undertake the following step of the assembly process.

Lift the main body ① and carefully place it onto the stand.

Position the main body towards the front of the stand, so that the screws built into the stand are not visible when viewed from above.

Gently slide the main body backwards until the base engages with the fixings and locks into place.



When lifting the main body onto the stand and sliding it into positing, be careful not to catch/trap hands and fingers.

Secure the main body to the stand using the four screws (with the flat washer and spring washer) ⑦.

First, loosely attach all four screws (again leaving a 1-2 mm tightening allowance), adjusting the position of the main body on the stand.

When all four screws are attached and the main body is correctly positioned on top of the stand, securely tighten all screws until the spring washers collapse.

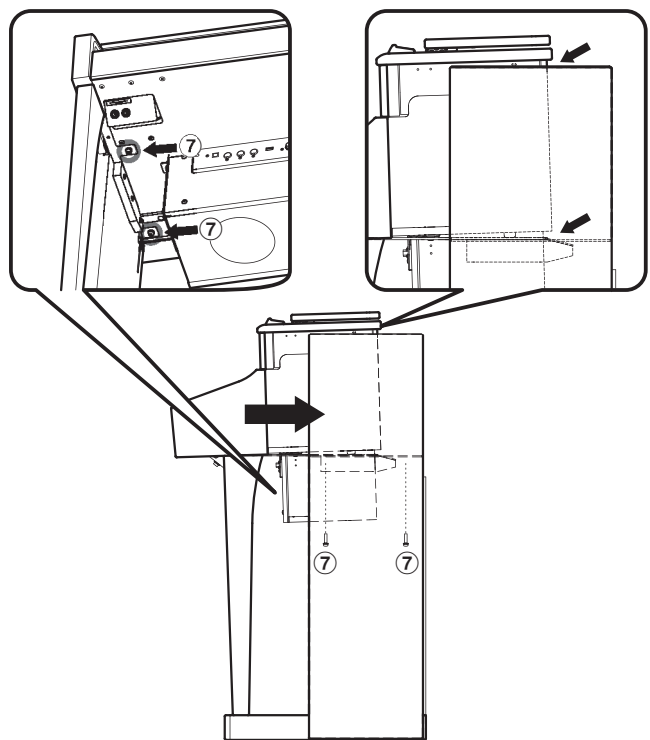

Tighten all of the other temporarily attached screws securely to ensure that the main body is firmly attached to the stand. Failing to do so may result in serious injury.

4. Attaching the front under board ③

Attach the front under board ③ to the metal brackets located underneath the main body using three short black screws ⑪.

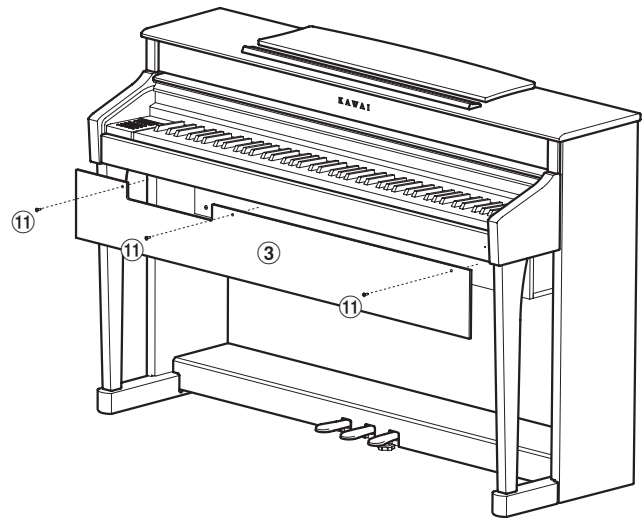

5. Connecting the pedal and power cables

Connect the pedal cable originating from the pedal board to the PEDAL terminal located on the rear of the main body, below the speaker box. Ensure that the notch in the pedal plug is facing upward when connecting.

Connect the power cable ⑥ to the AC IN terminal, also located on the rear of the main body, then use the binders to fix the cables into place.

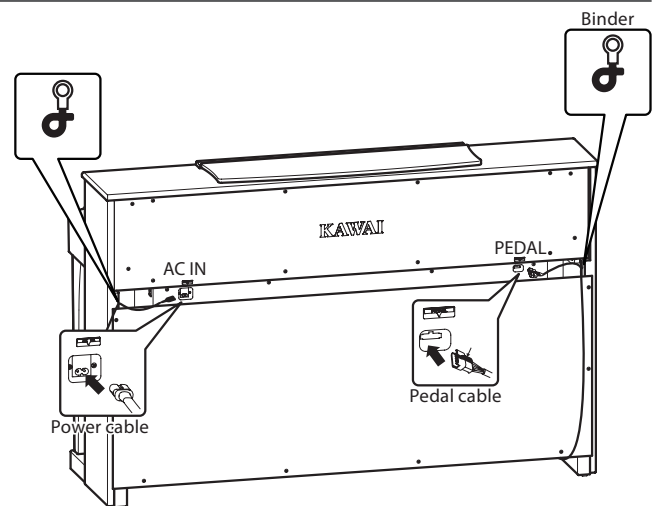

6. Attaching the headphone hook (optional)

If desired, attach the headphone hook to the underside of the main body using the two mounting screws provided.

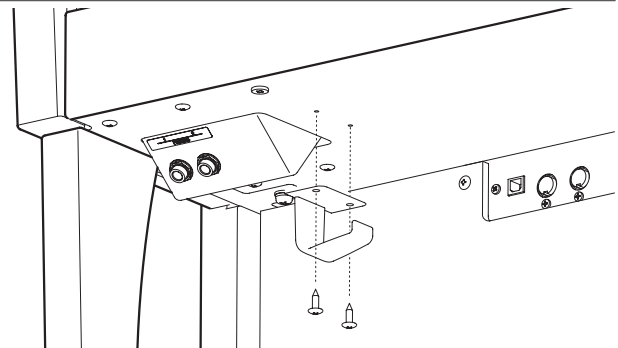

7. Adjusting the pedal support bolt

Turn the pedal support bolt anti-clockwise until it makes contact with the floor and supports the pedals firmly.

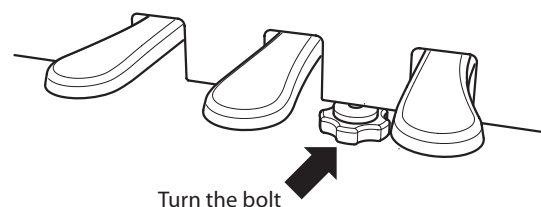

Specifications

■ Kawai CS6 digital piano

Keyboard	88 wooden keys RM3 Grand action with Ivory Touch and Let-Off	
Sound Source	Ultra Progressive Harmonic Imaging™ (UPHI)	
Internal Sounds	60 voices	
Polyphony	max. 192 notes	
Display	16 x 2 characters LCD	
Reverb	Room 1, Room 2, Stage, Hall 1, Hall 2	
Effects	Chorus, Delay 1, Delay 2, Delay 3, Tremolo, Rotary 1, Rotary 2	
Internal Recorder	10 song, 2 track recorder - approximately 90,000 note memory capacity	
USB Functions	Play Audio	MP3: 32 kHz/44.1 kHz/48 kHz, Mono/Stereo, Bitrate: 8-320 kbit/s (fixed & variable) WAV: 32 kHz/44.1 kHz/48 kHz, Mono/Stereo
	Record Audio	MP3: 44.1 kHz, 16 bit, Stereo, 192 kbit/s (fixed) WAV: 44.1 kHz, 16 bit, Stereo, 1,411 kbit/s (uncompressed)
	Other	Convert Song to Audio, SMF song player, Save Song, Load Song, Rename, Delete, Format
Storage	USB memory, USB floppy disk drive	
Lesson Function	Lesson Songs (varies depending on market area) and Finger Exercises	
Metronome	Beat: 1/4, 2/4, 3/4, 4/4, 5/4, 3/8, 6/8, 7/8, 9/8, 12/8 Rhythm: 100 types	
Demo Songs	34 songs	
Piano Music	29 or 42 pieces (depending on market area)	
Concert Magic	176 songs	
Virtual Technician	Voicing, Damper Resonance, String Resonance, Key-off Effect, Touch Curve (incl. 2 user touch curves), Temperament (incl. user temperament), Key of Temperament, Stretch Tuning	
Keyboard Modes	Dual Mode, Split Mode, Four Hands Mode (incl. volume/balance adjust)	
Other Functions	Key/Song Transpose, Tone Control, Speaker Volume, Headphone Volume, Tuning, Damper Hold, Lower Octave Shift, Lower Pedal, Layer Octave Shift, Layer Dynamics, Panel Registration memories, MIDI Functions and settings, User Memory, Factory Reset, Auto Power Off	
Pedals	Sustain (with half-pedal support), Soft, Sostenuto	
Jacks	MIDI (IN/OUT/THRU), USB to Host, USB to Device, LINE IN (L/MONO, R), LINE IN Level Adjust, STEREO IN, LINE OUT (L/MONO, R), Headphones x 2	
Speakers	13 cm x 2 (full range speakers) 5 cm x 2 (tweeters)	
Output Power	50 W x 2	
Power Consumption	80 W	
Key Cover	Sliding type	
Dimensions (Not including music rack)	1447 (W) x 472 (D) x 950 (H) mm 57" (W) x 18 1/2" (D) x 37 1/2" (H)	
Weight	80 kg / 176.3 lbs.	

MIDI Implementation Chart

■ Kawai CS6 digital piano

Date : Dec '10 Version : 1.0

Function		Transmit	Receive	Remarks
Basic channel	At power-up	1	1	
	Settable	1 - 16	1 - 16	
Mode	At power-up	Mode 3	Mode 1	** Omni mode is on at power-up. Omni mode can be turned off through MIDI channel setting operations.
	Message	×	Mode 1, 3**	
	Alternative	*****	×	
Note number		21 - 108*	0 - 127	* 9-120, including transpose
	Range	*****	0 - 127	
Velocity	Note on	○ 9nH v=1-127	○	
	Note off	× 9nH v=0	×	
After touch	Key specific	×	×	
	Channel specific	×	×	
Pitch bend		×	×	
Control change	0.32	○	○	Bank select
	7	×	○	Volume
	10	×	○	Panpot
	11	×	○	Expression pedal
	64	○ (Right pedal)	○	Damper pedal
	66	○ (Middle pedal)	○	Sostenute pedal
	67	○ (Left pedal)	○	Soft pedal
Program change settable range	○ (0 - 127) *****	○ (0 - 127)		
Exclusive		○	○	Transmission can be selected
Common	Song position	×	×	
	Song selection	×	×	
	Tune	×	×	
Real time	Clock	×	×	
	Commands	×	×	
Other functions	Local On / Off	×	○	
	All notes Off	×	○ (123 - 127)	
	Active sensing	○	○	
	Reset	×	×	
Remarks				

Mode 1: omni mode On, Poly
Mode 3: omni mode Off, Poly

Mode 2: omni mode On, Mono
Mode 4: omni mode Off, Mono

○ : Yes
× : No

KAWAI

THE FUTURE OF THE PIANO

CS6 Owner's Manual

KPSZ-0457 : 817025

OW1052E-S1012

Version 1

Printed in Indonesia

Copyright © 2010 Kawai Musical Instruments Mfg. Co.,Ltd. All Rights Reserved.